



# Guardian FABXR Bracket

➤ Assembly & Operation Guide

# Contents

## **Assembly Instructions** **4**

Porta Gantry Rapide 500 5

Porta Gantry Rapide 1000 7

Porta Gantry; S & M 9

Porta Gantry 12

T Davit 14

Porta Davit 500 16

Porta Davit Quantum 18

Porta Davit Quantum Single Winch 21

Porta Davit Quantum Double Winch 23

Fitting device into Bracket 25



# Lightweight. Portable. **Safe.**

Please read the following instructions and guidance notes carefully. These have been designed to aid users in carrying out the correct assembly of the bracket for each of our compatible lifting systems. Systems compatible with this product are:

- **PORTAGANTRY**\*
- **PORTAGANTRY**[RAPIDE]
- **TDAVIT**\*
- **PORTADAVIT**
- **PORTADAVIT**[QUANTUM]\*

# ➤ Assembly Instructions: PORTAGANTRY® 500

The following instructions detail the assembly of the Guardian FABXR Bracket [RAW8007020] for the Porta Gantry Rapide, both Small [S] and Medium [M] frame types.

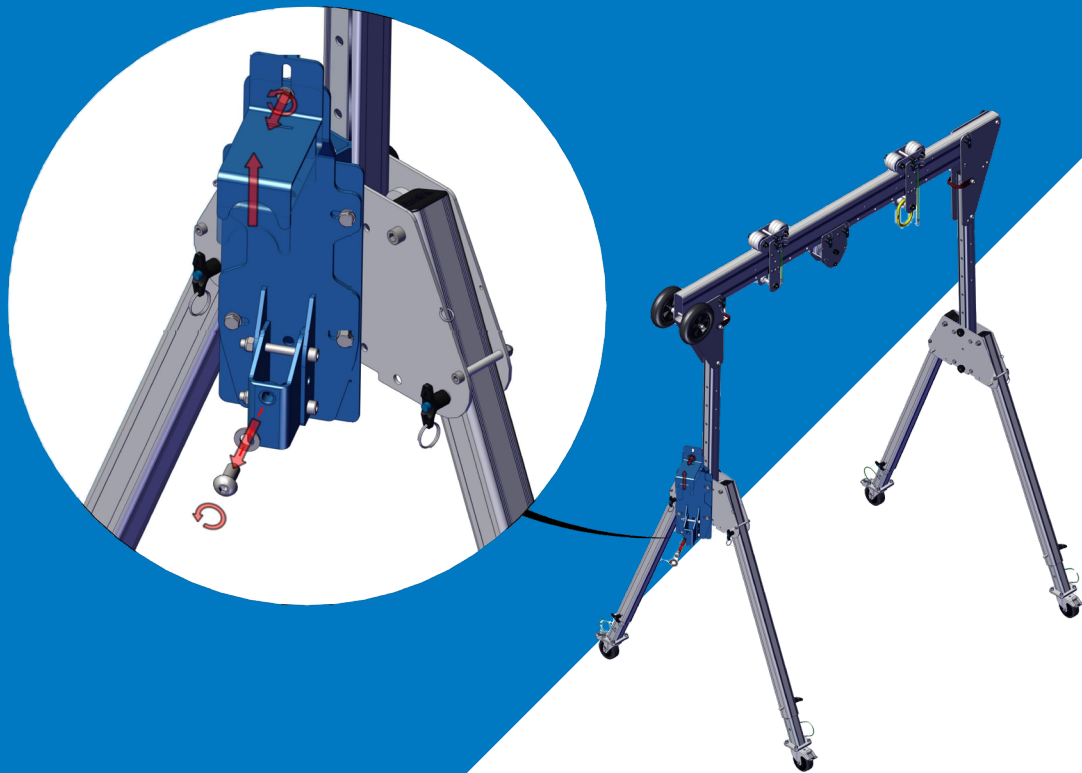

Appropriate PPE should be worn: ➤ Gloves ➤ Protective Footwear

### Assembling the PORTA GANTRY RAPIDE 500: Guardian FABXR Bracket

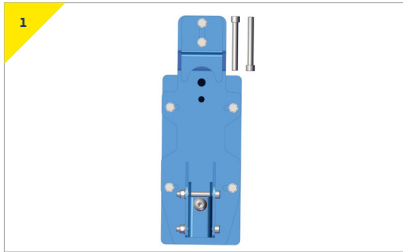

- The bracket comes with the bolts supplied, as shown above.

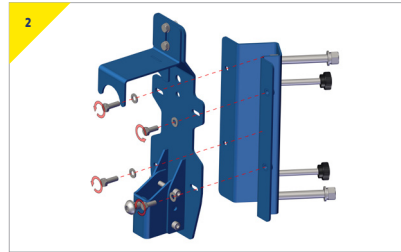

- Before attaching the bracket to the device, disassemble the bracket.

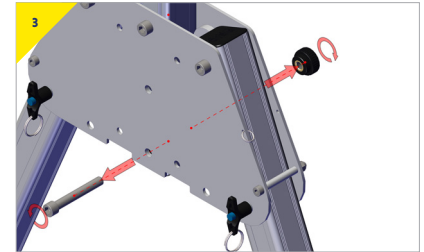

- Remove the bottom bolt from the trap plate.

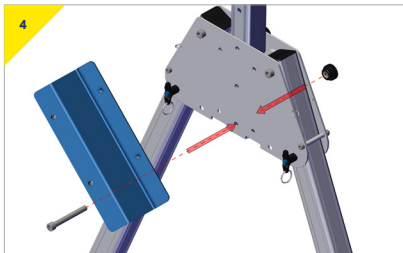

- Present the bracket to the trap plate, insert and secure the M12 bolt supplied with the bracket.

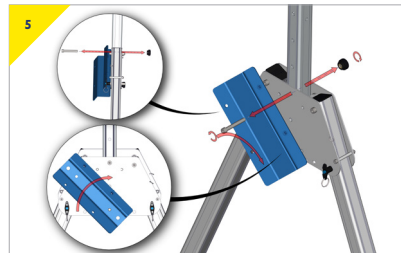

- Remove the top bolt whilst holding the bracket on an angle.

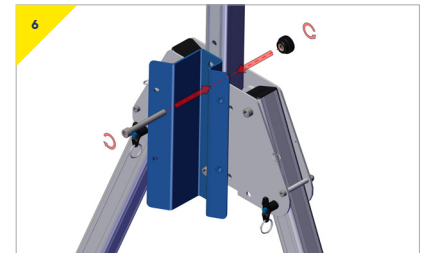

- Insert the supplied M12 top bolt and secure.

### Assembling the PORTA GANTRY RAPIDE 500: Guardian FABXR Bracket

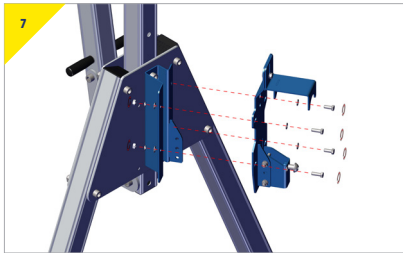

- Re-assemble the bracket to the plate.



- Prepare the bracket to receive the device and remove the bolt from the bottom connector and loosen the top connector.

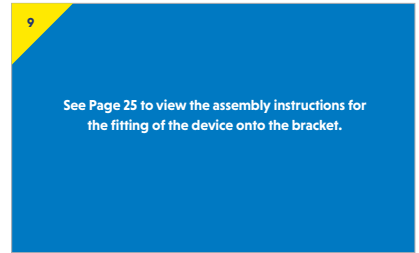

# ➤ Assembly Instructions: PORTAGANTRY® 1000

The following instructions detail the assembly of the Guardian FABXR Bracket [RAW8007020] for the Porta Gantry Rapide, both Small [S] and Medium [M] frame types.

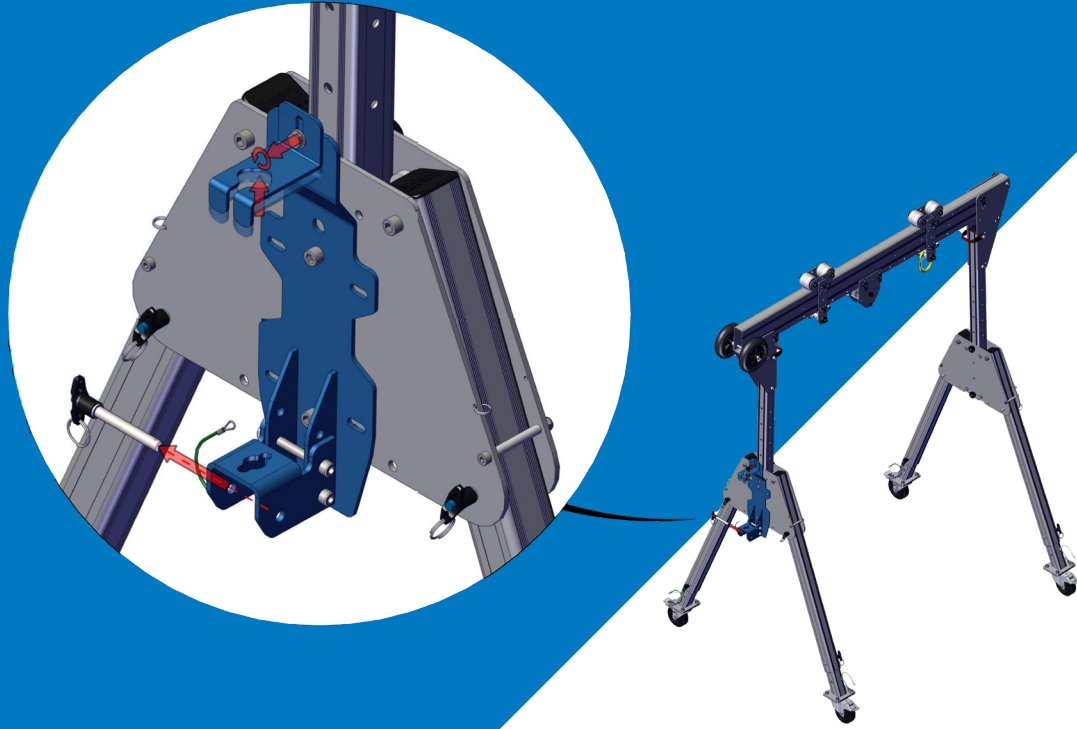

Appropriate PPE should be worn: ➤ Gloves ➤ Protective Footwear

### Assembling the PORTA GANTRY RAPIDE 1000: Guardian FABXR Bracket

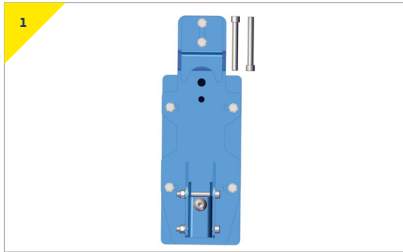

- The bracket comes with the bolts supplied, as shown above.

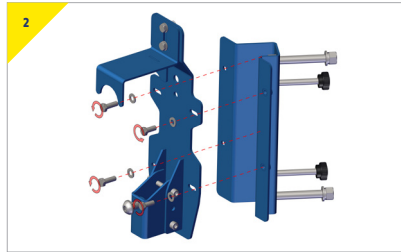

- Before attaching the bracket to the device, disassemble the bracket.

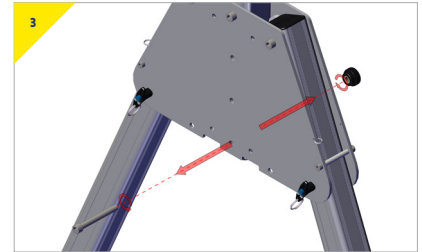

- Remove the bottom bolt from the trap plate.

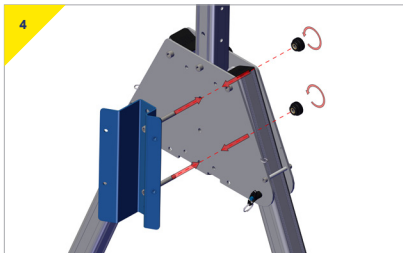

- Present the bracket to the trap plate, insert and secure the top and bottom M12 bolts supplied with the bracket.

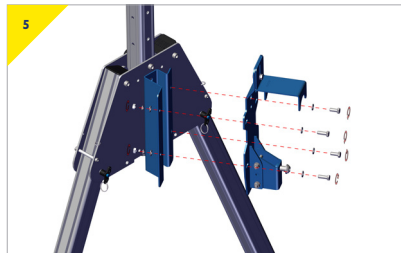

- Remove the top bolt whilst holding the bracket on an angle.



- Prepare the bracket to receive the device and remove the bolt from the bottom connector and loosen the top connector.



# ➤ Assembly Instructions: PORTAGANTRY®; S & M

The following instructions detail the assembly of the Guardian FABXR Bracket [RAWB007020] for the Porta Gantry, both Small [S] and Medium [M] frame types.

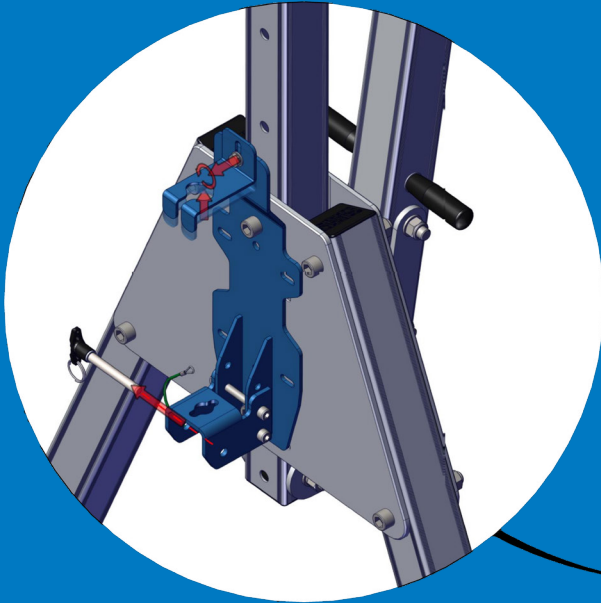

Appropriate PPE should be worn: ➤ Gloves ➤ Protective Footwear

### Assembling the PORTA GANTRY: Guardian FABXR Bracket

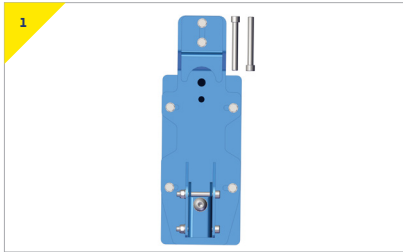

- The bracket comes with the bolts supplied, as shown above.

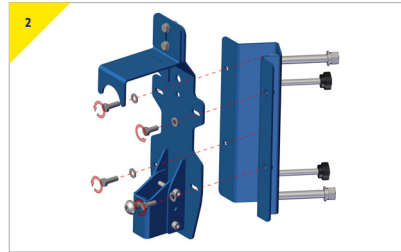

- Before attaching the bracket to the device, disassemble the bracket.

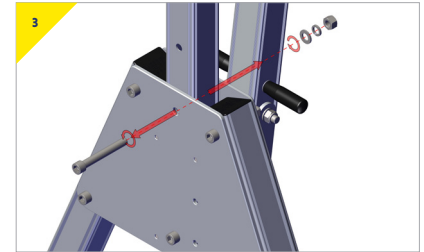

- Remove the bottom bolt from the trap plate.

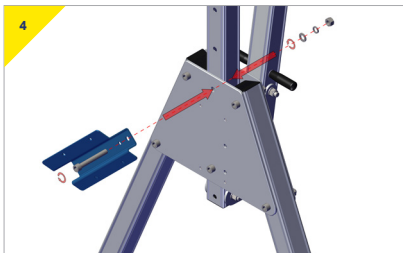

- Present the bracket to the trap plate, insert and secure the M16 bolt supplied with the bracket.

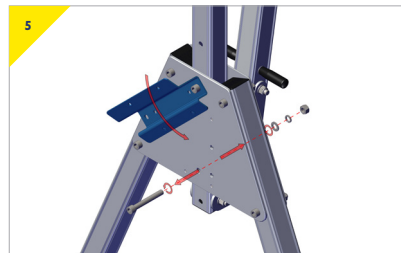

- Remove the bottom bolt from the trap plate, and wing the bracket into position.

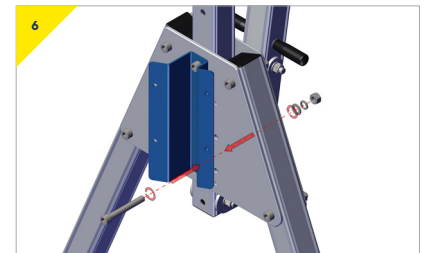

- Insert the bottom M16 bolt supplied with bracket and secure.

# > Assembly Instructions

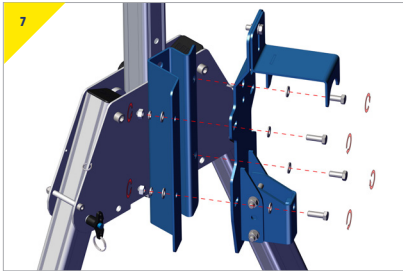

- > Re-assemble the bracket to the plate.

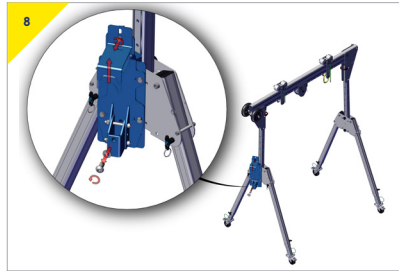

- > Prepare the bracket to receive the device, and remove the bolt from the bottom connector and loosen the top connector.

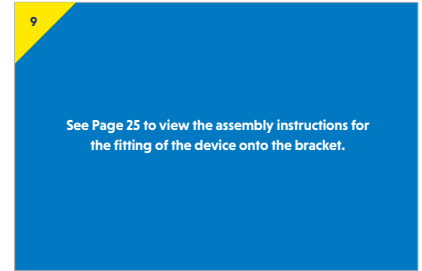

See Page 25 to view the assembly instructions for the fitting of the device onto the bracket.

# ➤ Assembly Instructions: PORTAGANTRY®

The following instructions detail the assembly of the Guardian FABXR Bracket [RAWB007000] for the Davits & Gantry Winch Column.

Appropriate PPE should be worn: ➤ Gloves ➤ Protective Footwear



Assembling the PORTA GANTRY Intermediate and above sizes: Guardian FABXR Bracket

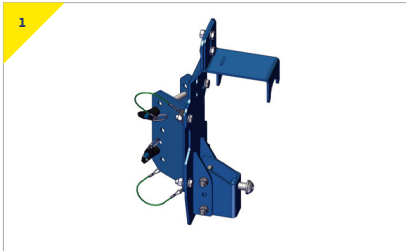

> The bracket comes with the pins supplied, as shown above.

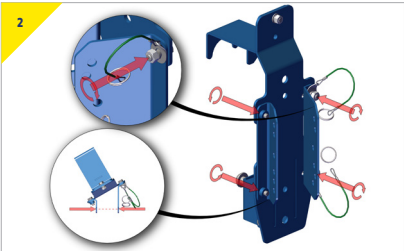

> Adjust the width of the wings to 3" (76.2mm) to fit on the winch column.

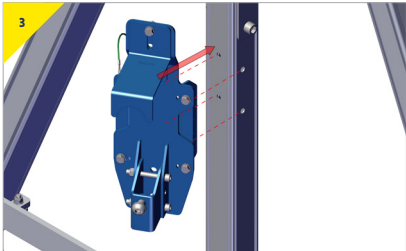

> Present the bracket onto the winch column.

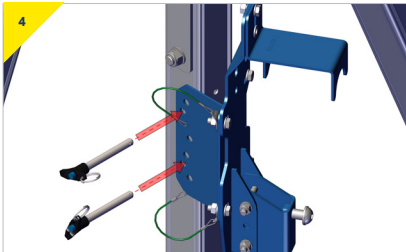

> Insert pins provided to secure bracket to section.



> Prepare the bracket to receive the device and remove the bolt from the bottom connector and loosen the top connector.

6  
See Page 25 to view the assembly instructions for the fitting of the device onto the bracket.

# ➤ Assembly Instructions: TDAVIT®

The following instructions detail the assembly of the Guardian FABXR Bracket [RAWB007000] for the Davits & Gantry Winch Column.

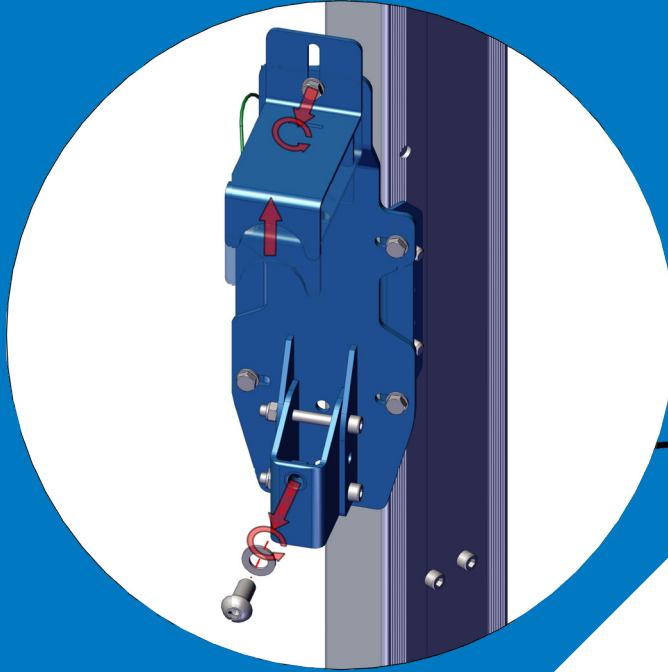

Appropriate PPE should be worn: ➤ Gloves ➤ Protective Footwear

Assembling the T DAVIT: Guardian FABXR Bracket

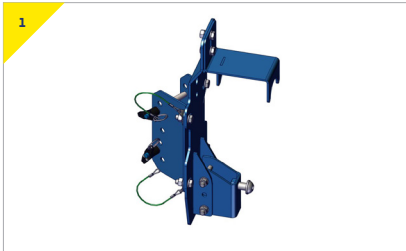

➤ The bracket comes with the pins supplied, as shown above.

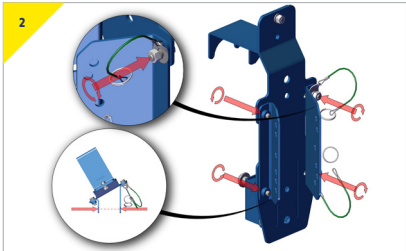

➤ Adjust the width of the wings to 3" (76.2mm) to fit on the T davit column section.

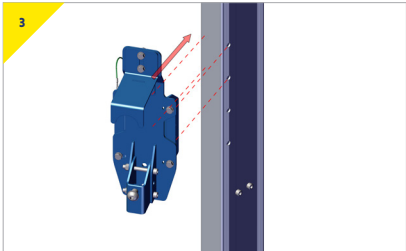

➤ Present to the T-Davit column.

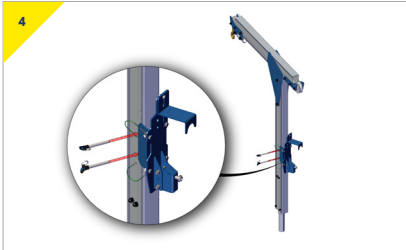

➤ Insert the pins provided to secure bracket to the section.

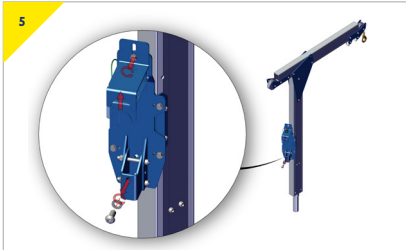

➤ Prepare the bracket to receive the device and remove the bolt from the bottom connector and loosen the top connector.

➤ See Page 25 to view the assembly instructions for the fitting of the device onto the bracket.

# ➤ Assembly Instructions: PORTADAVIT 500

The following instructions detail the assembly of the Guardian FABXR Bracket [RAWB007000] for the Davits & Gantry Winch Column.

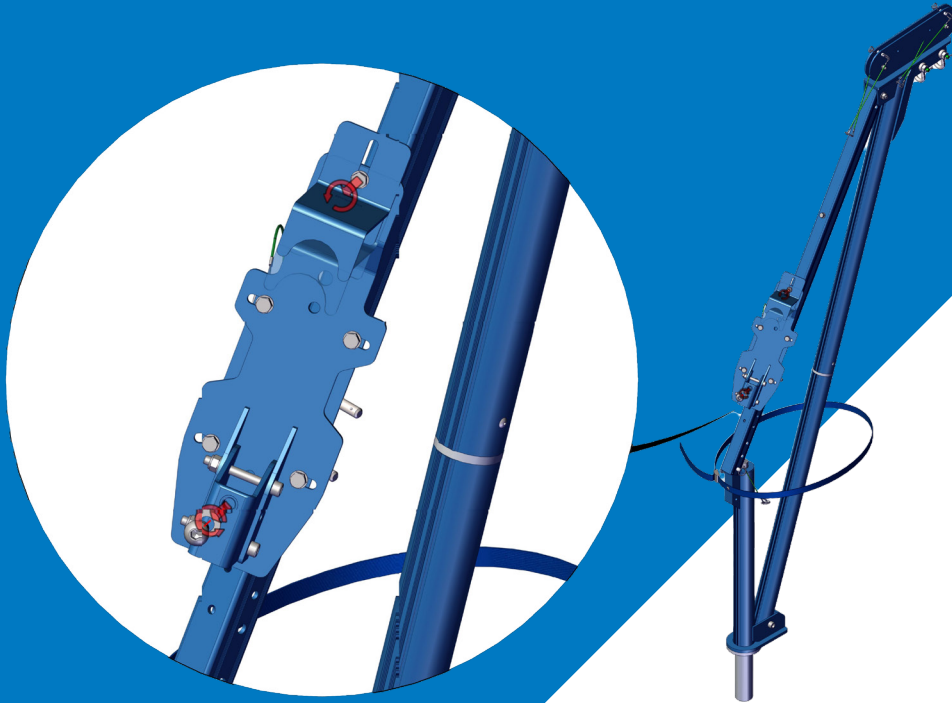

Appropriate PPE should be worn: ➤ Gloves ➤ Protective Footwear



Assembling the PORTA DAVIT 500: Guardian FABXR Bracket

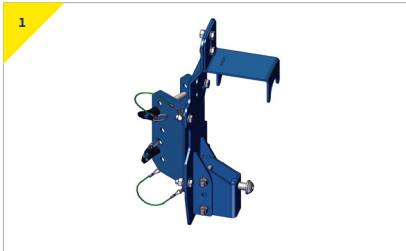

› The bracket comes with the pins supplied, as shown above.

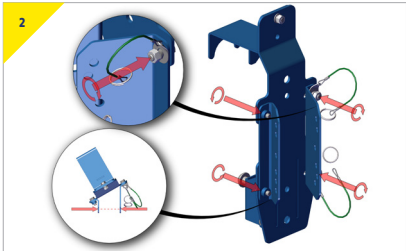

› Adjust the width of the wings to 2" (50.8mm) to fit on the Porta Davit 500 backstay.

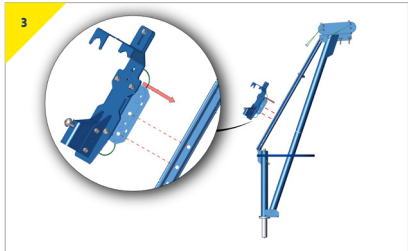

› Present the bracket onto the Porta Davit 500 backstay.

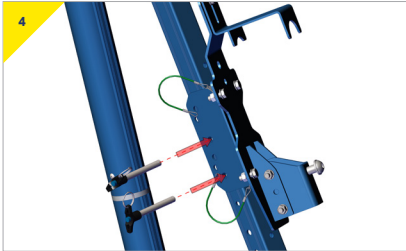

› Insert the pins provided through the bracket.

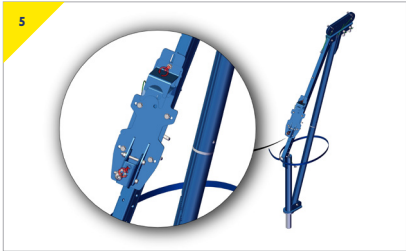

› Prepare the bracket to receive the device and remove the bolt from the bottom connector and loosen the top connector.

6  
See Page 25 to view the assembly instructions for the fitting of the device onto the bracket.

# > Assembly Instructions: PORTA DAVIT QUANTUM®

The following instructions detail the assembly of the Guardian FABXR Bracket [RAWB007000] for the Davits & Gantry Winch Column.

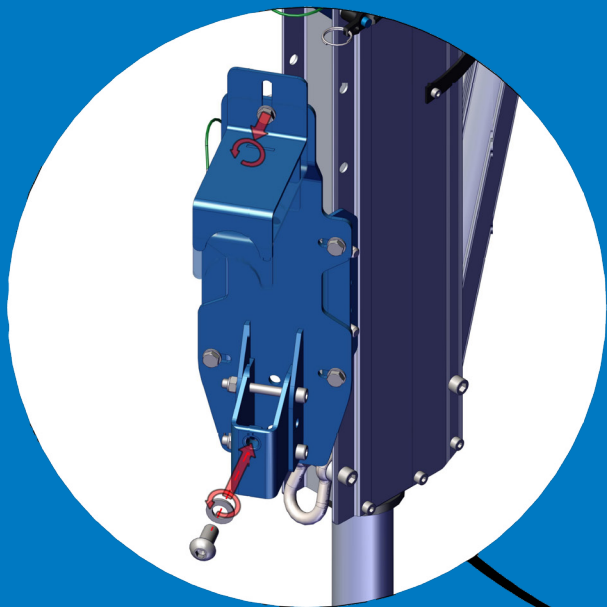

Appropriate PPE should be worn: > **Gloves** > **Protective Footwear**

Assembling the PORTA DAVIT QUANTUM: Guardian FABXR Bracket

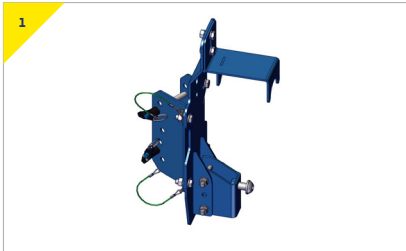

> The bracket comes with the bolts supplied, as shown above.

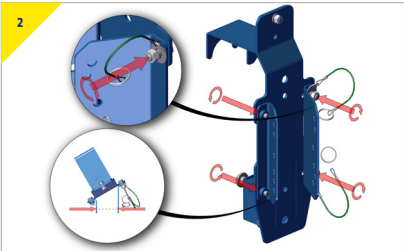

> Adjust the width of the wings to 3" (76.2mm) and fit the bracket onto the Porta Davit Quantum column.

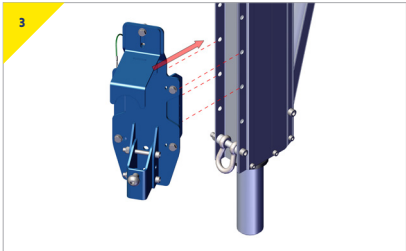

> Present the bracket into the Porta Davit Quantum column.

For this configuration a sheave bracket column is required.  
RAWB000095 – Sheave bracket PDQ column Medium sheave (4-7mm).

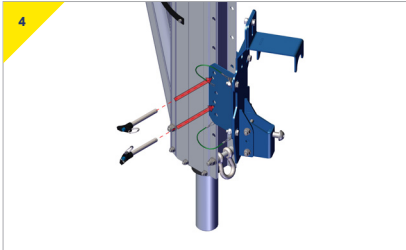

> Insert the pins provided with the bracket.

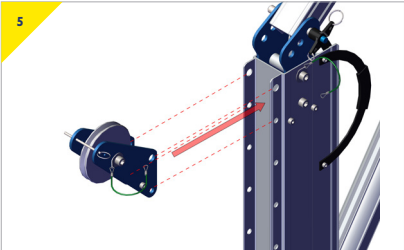

> Present the sheave bracket to the top of the column.

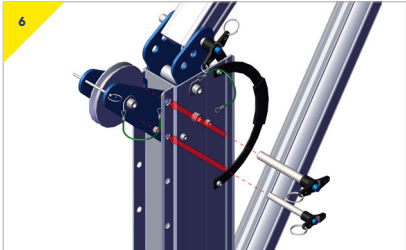

> Insert the pins provided.

## ➤ Assembly Instructions

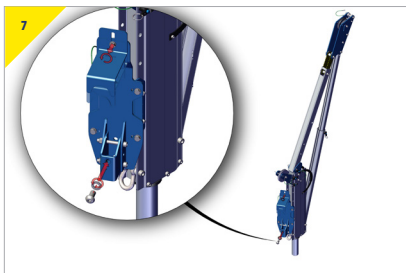

- Prepare the bracket to receive the device and remove the bolt from the bottom connector and loosen the top connector.

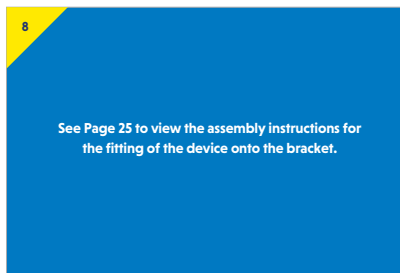

# ➤ Assembly Instructions: PORTA DAVIT QUANTUM®

The following instructions detail the assembly of the Guardian FABXR Bracket [RAWB007000] for the Davits & Gantry Winch Column.

Appropriate PPE should be worn: ➤ Gloves ➤ Protective Footwear

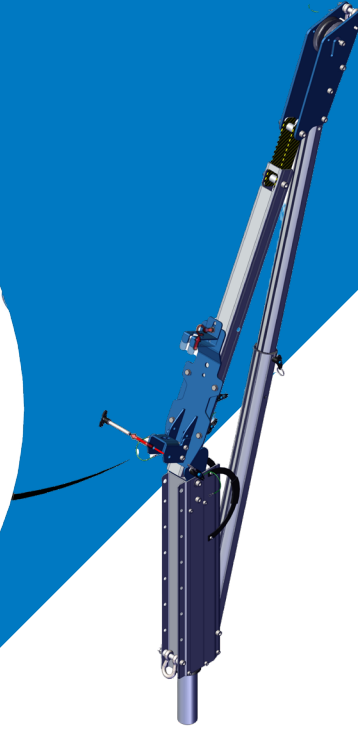
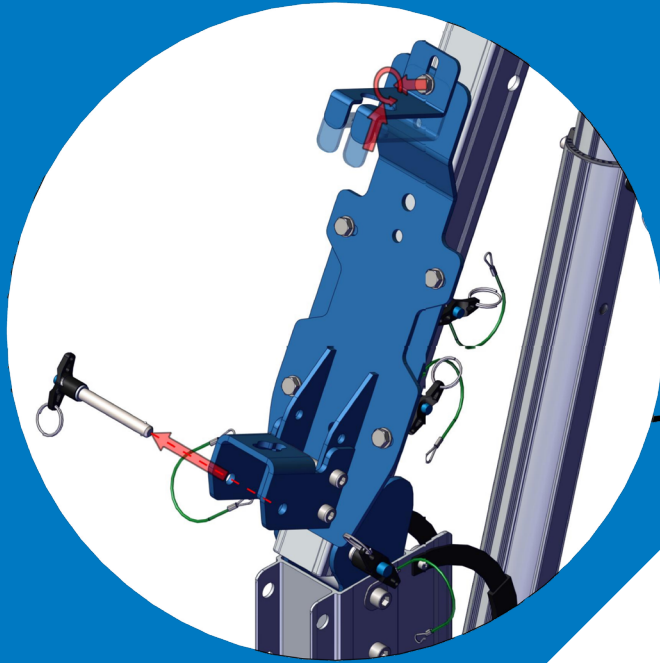

Assembling the PORTA DAVIT QUANTUM Backstay Single Winch: Guardian FABXR Bracket

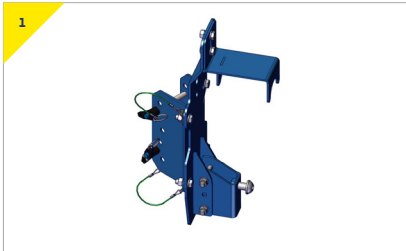

➤ The bracket comes with the pins supplied, as shown above.

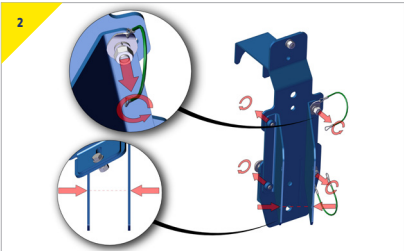

➤ Adjust the width of the wings to 2 1/2" (63.5mm) and fit the bracket onto the Porta Davit Quantum backstay.

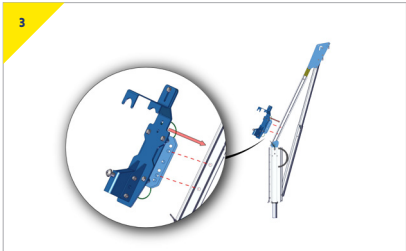

➤ Present the bracket into the Porta Davit Quantum backstay.

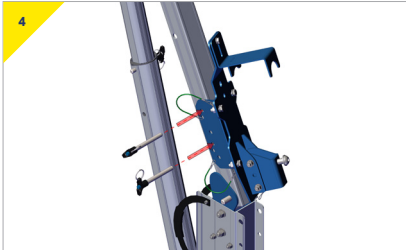

➤ Insert the pins provided with the bracket.

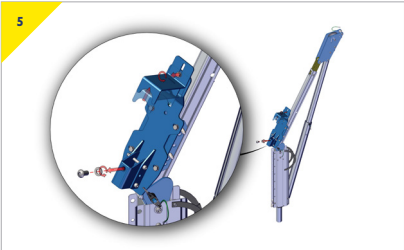

➤ Prepare the bracket to receive device, remove the bolt from the bottom connector and loosen the top connector.

6  
See Page 25 to view the assembly instructions for the fitting of the device onto the bracket.

# > Assembly Instructions: PORTA DAVIT QUANTUM®

The following instructions detail the assembly of the Bracket Kit Guardian FABXR [RAWB007010] for the PORTA DAVIT QUANTUM Backstay (Double Winch).

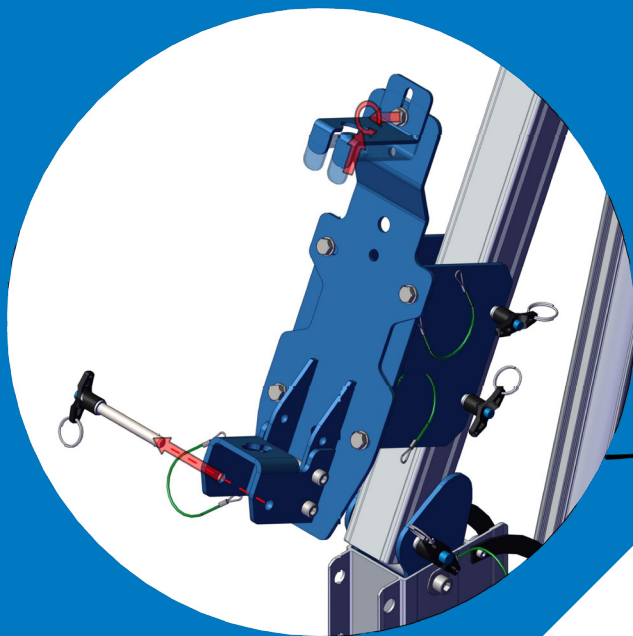

Appropriate PPE should be worn: > **Gloves** > **Protective Footwear**

Assembling the PORTA DAVIT QUANTUM Double Winch: Guardian FABXR Bracket

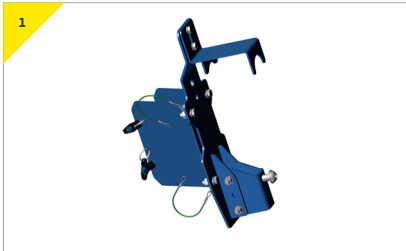

➤ The bracket comes with the pins supplied, as shown above.

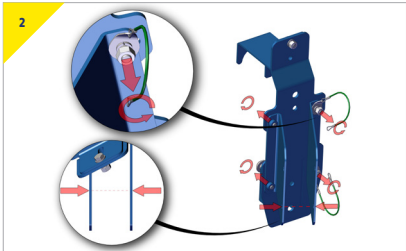

➤ Adjust the width of the wings to 2 1/2" (76.2mm) and fit the bracket onto the Porta Davit Quantum backstay.

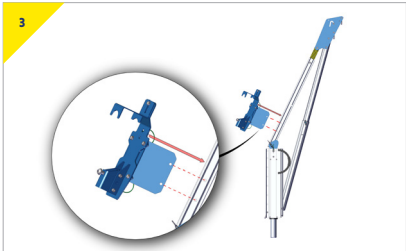

➤ Present the bracket into the Porta Davit Quantum backstay.

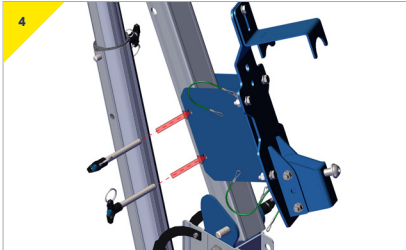

➤ Insert the pins provided with the bracket.

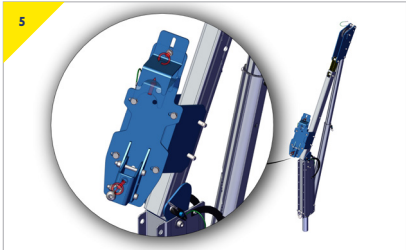

➤ Prepare the bracket to receive device, remove the bolt from the bottom connector and loosen the top connector.

6  
See Page 25 to view the assembly instructions for the fitting of the device onto the bracket.



## Fit the Device onto the Bracket



➤ Present the device onto the bracket.

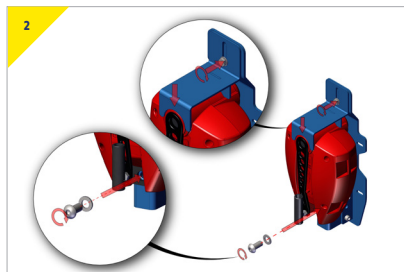

➤ Insert the bottom bolt to secure the device into position. Adjust the top connector in the suitable position and secure by tightening the bolt.

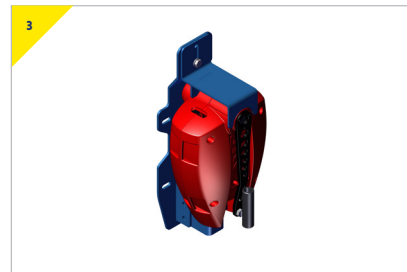

➤ The device is now ready to use.

# Contact Us

## Head Office, UK

Unit 1 Wyeview  
Newhouse Farm Industrial Estate  
Chepstow  
Monmouthshire  
NP16 6UD  
United Kingdom

- > +44 (0)1291 620 796
- > [enquiries@reidlifting.com](mailto:enquiries@reidlifting.com)
- > [www.reidlifting.com](http://www.reidlifting.com)

All information herein is copyright protected by REID Lifting Ltd. All company and product names are Trade Mark and Trade Name protected and all REID Lifting Ltd. Product IPR is protected under Patents, Patents Pending and/or Design Rights.

 Printed using environment friendly processes and materials.