



# 3M™ DBI-SALA® Ultra-Lok™ Bracket

➤ Assembly & Operation Guide

# Contents

Fitting device into Bracket - Trap Plates	4
Fitting device into Bracket - Columns	6
<b>PORTA</b> GANTRY <small>RAPIDE</small> 500	8
<b>PORTA</b> GANTRY <small>RAPIDE</small> 1000	10
<b>PORTA</b> GANTRY <sup>®</sup> Small & Medium	12
<b>PORTA</b> GANTRY <sup>®</sup>	14
<b>T</b> DAVIT <sup>®</sup>	16
<b>PORTA</b> DAVIT <small>QUANTUM</small> Column	18
<b>PORTA</b> DAVIT <small>QUANTUM</small> Backstay Single Winch	20
<b>PORTA</b> DAVIT <small>QUANTUM</small> Backstay Double Winch	22
<b>PORTA</b> DAVIT <sup>®</sup> 500	24
<b>PORTX</b> <sup>®</sup> DAVIT	26

# Lightweight. Portable. **Safe.**

Please read the following instructions and guidance notes carefully. These have been designed to aid users in carrying out the correct assembly of the bracket for each of our compatible lifting systems. Systems compatible with this product are:

- PORTAGANTRY<sup>®</sup> RAPIDE<sup>®</sup>
- PORTAGANTRY<sup>®</sup>
- TDAVIT<sup>®</sup>
- PORTADAVIT<sup>®</sup> QUANTUM<sup>®</sup>
- PORTADAVIT<sup>®</sup>
- PORTX<sup>®</sup> DAVIT

## General Specification

- Maximum rated capacity for fall protection - 1 person
- Ensure the rating of the Winch is always checked before use
- For use with REID lifting products only

## Standards

- EN795:2012 Type B
- EN1496:2017

For further information please refer to the technical data sheet for this product.

**For operations guide and technical specifications for the device, please refer to the manufacturer's dedicated guide.**

## ➤ Fitting the Device - Trap Plates

The following instructions detail the assembly of the 3M™ DBI-SALA® Ultra-Lok™ device into the bracket on trap plate attachments.



Appropriate PPE should be worn: ➤ **Gloves** ➤ **Protective Footwear**

3M™ DBI-SALA® Ultra-Lok™ Bracket

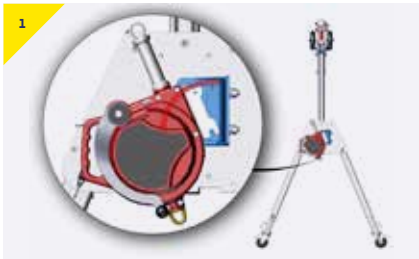

> Present the device to the bracket.

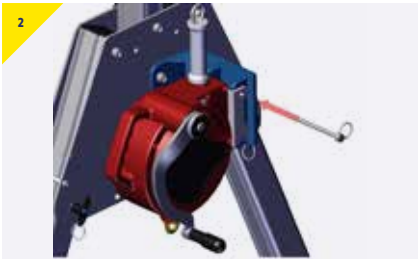

> Insert the pin provided to secure the device.

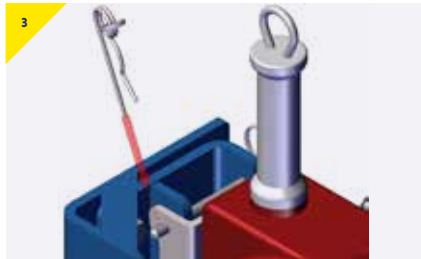

> Secure the pin using the R-clip provided.



> Device is secure and ready to use.

## ➤ Fitting the Device - Columns

The following instructions detail the assembly of the 3M™ DBI-SALA® Ultra-Lok™ device into the bracket.



Appropriate PPE should be worn: ➤ **Gloves** ➤ **Protective Footwear**

**3M™ DBI-SALA® Ultra-Lok™ Bracket**

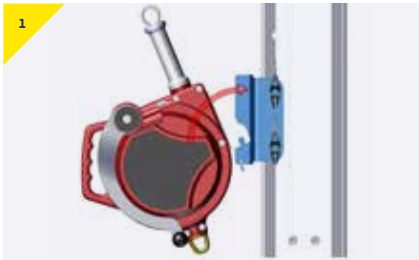

> Present the device to the bracket.

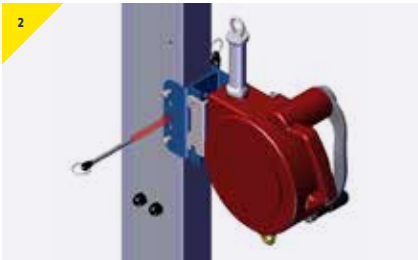

> Insert the pin provided to secure the device.



> Device is secure and ready to use.

# ▶ PORTAGANTRY RAPIDE® 500

The following instructions detail the assembly of the 3M™ DBI-SALA® Ultra-Lok™ bracket [RAWB003525] for the PORTAGANTRY RAPIDE 500kg.

Appropriate PPE should be worn: ▶ Gloves ▶ Protective Footwear





## 3M™ DBI-SALA® Ultra-Lok™ Bracket - [RAWB003525]

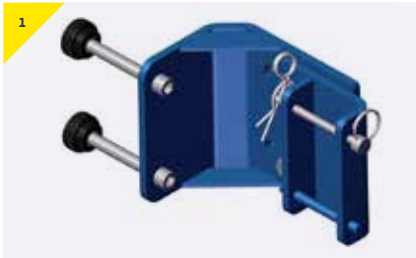

> Bracket is supplied with bolts and pins as shown.

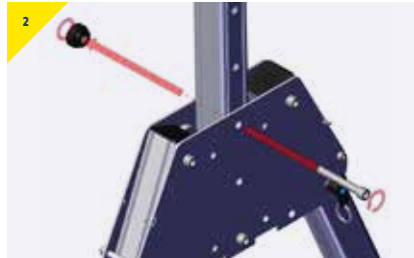

> Remove the top bolt from the trap plate.

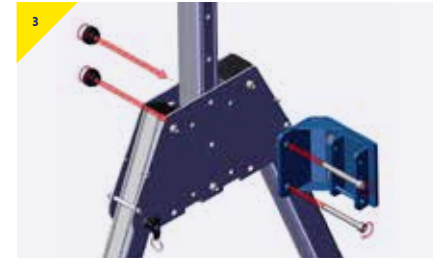

> Present the bracket to the trap plate, securing using the M12 bolts supplied.



> The bracket is now ready to receive the device.

# ▶ PORTAGANTRY **RAPIDE**® 1000

The following instructions detail the assembly of the 3M™ DBI-SALA® Ultra-Lok™ bracket [RAWB003525] for the **PORTAGANTRY **RAPIDE**** 1000kg.

Appropriate PPE should be worn: ▶ Gloves ▶ Protective Footwear

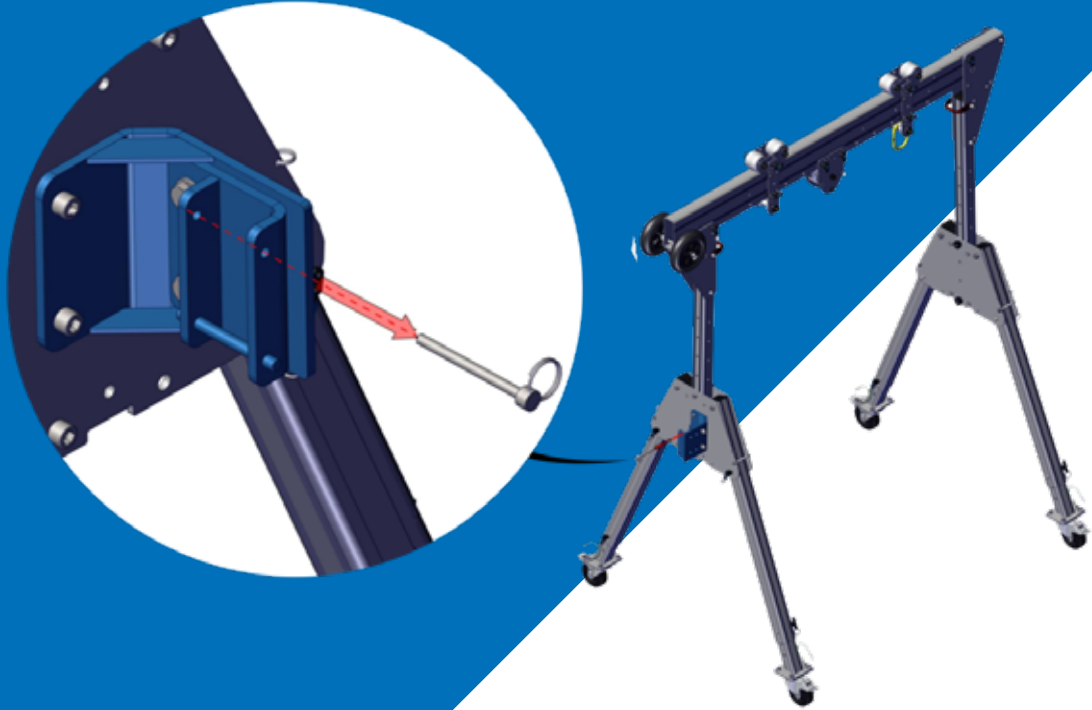

## 3M™ DBI-SALA® Ultra-Lok™ Bracket - [RAWB003525]

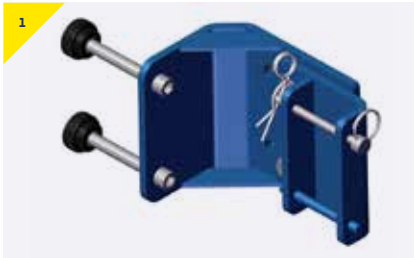

➤ Bracket is supplied with bolts and pins as shown.

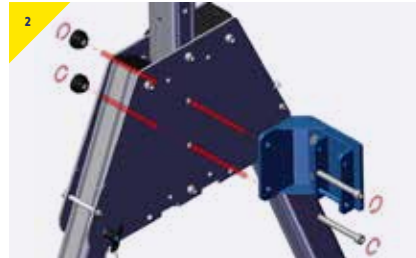

➤ Present the bracket to the trap plate, securing using the M12 bolts supplied.



➤ The bracket is now ready to receive the device.

# ▶ PORTAGANTRY® Small & Medium

The following instructions detail the assembly of the 3M™ DBI-SALA® Ultra-Lok™ bracket [RAWB003520] for the PORTAGANTRY® Small and Medium frame sizes.

Appropriate PPE should be worn: ▶ Gloves ▶ Protective Footwear

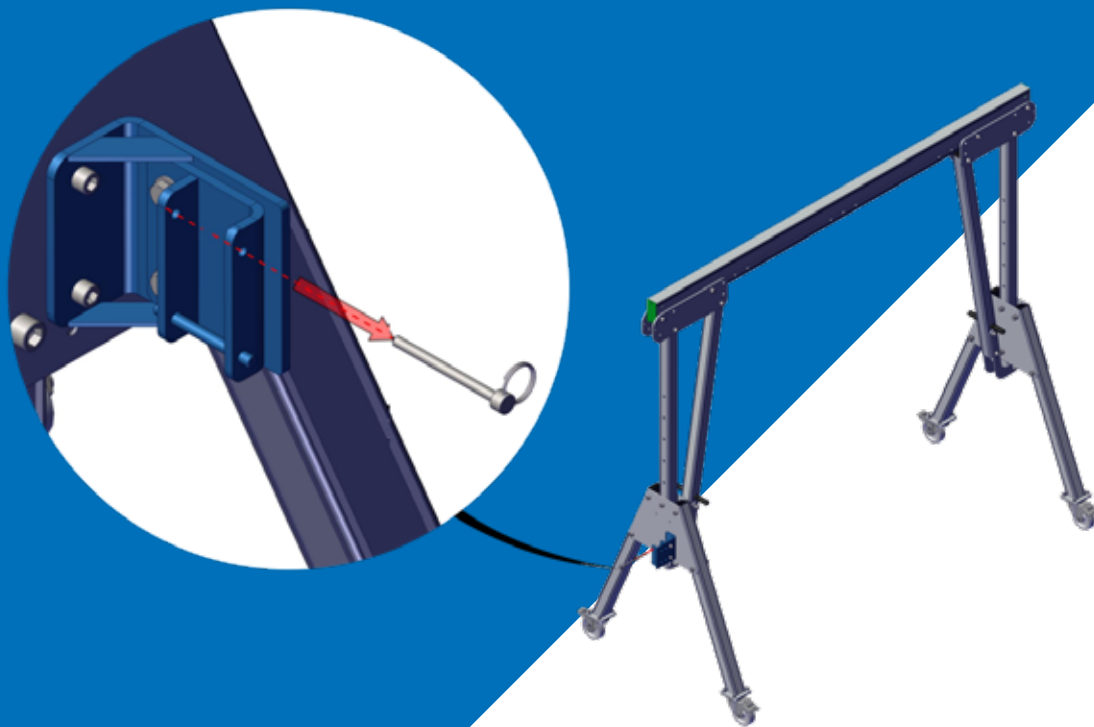

## 3M™ DBI-SALA® Ultra-Lok™ Bracket - [RAWB003520]



➤ Bracket is supplied with bolts and pins as shown.

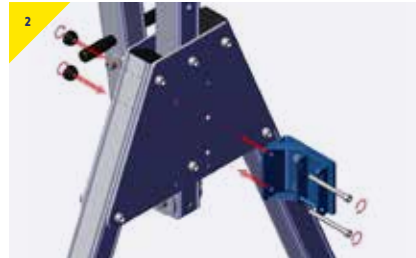

➤ Present the bracket to the trap plate, securing using the M12 bolts supplied.



➤ The bracket is now ready to receive the device.

# > PORTAGANTRY®

The following instructions detail the assembly of the 3M™ DBI-SALA® Ultra-Lok™ bracket [RAWB003000] for the PORTAGANTRY®.

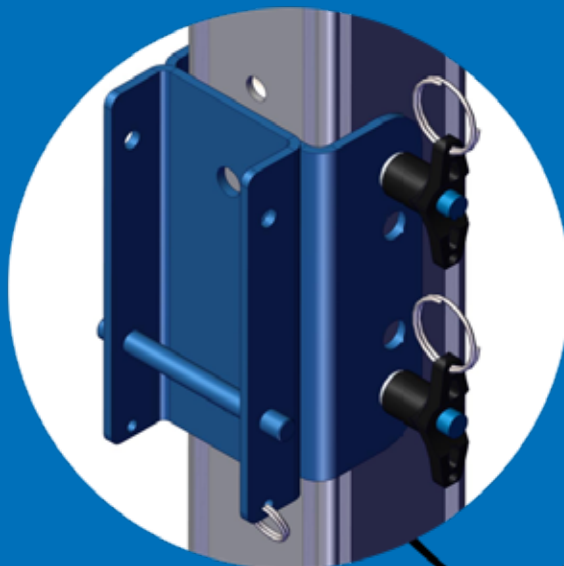

Appropriate PPE should be worn: > Gloves > Protective Footwear

# 3M™ DBI-SALA® Ultra-Lok™ Bracket - [RAWB003000]



> Bracket is supplied with pins as shown.

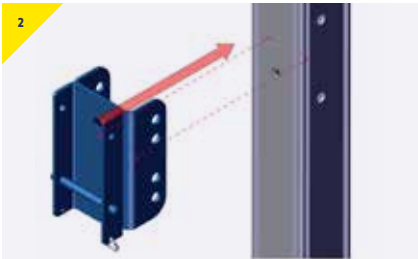

> Present the bracket to the column as shown.

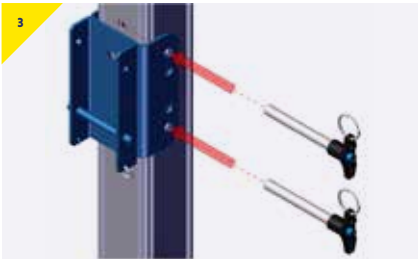

> Secure using the pins provided.

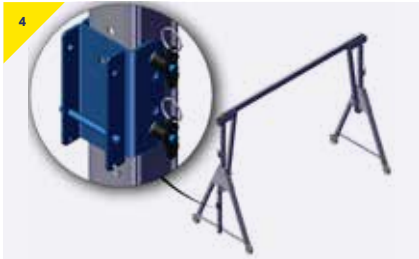

> The bracket is now ready to receive the device.



The following instructions detail the assembly of the 3M™ DBI-SALA® Ultra-Lok™ bracket [RAWB003000] for the TDAVIT®.

Appropriate PPE should be worn: [Gloves](#) [Protective Footwear](#)

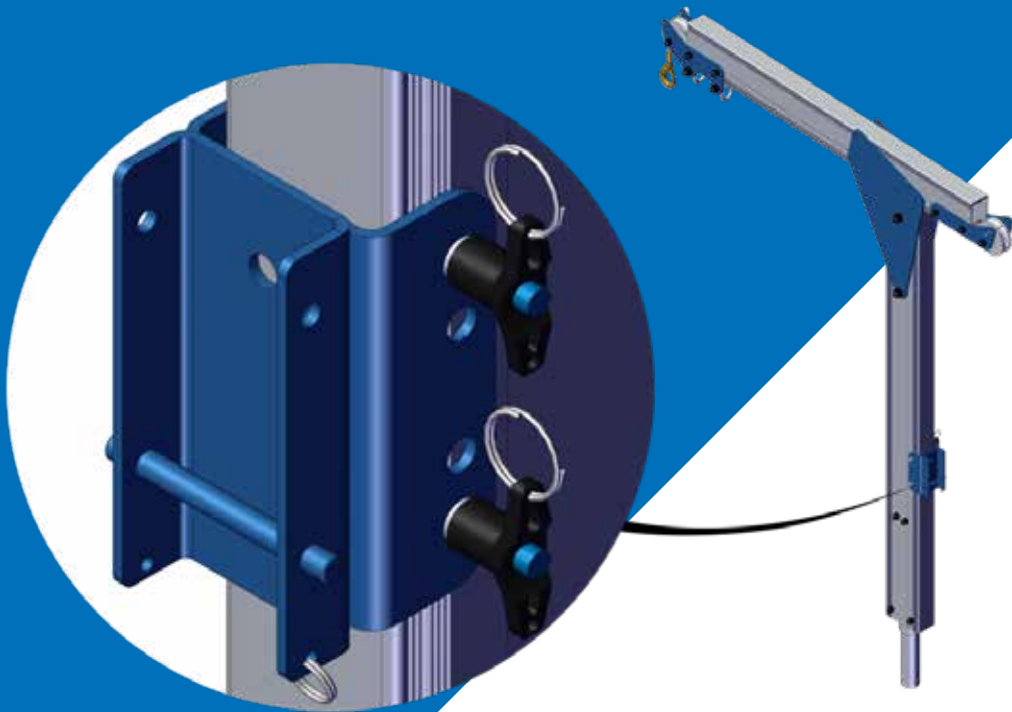



3M™ DBI-SALA® Ultra-Lok™ Bracket - [RAWB003000]



> Bracket is supplied with pins as shown.

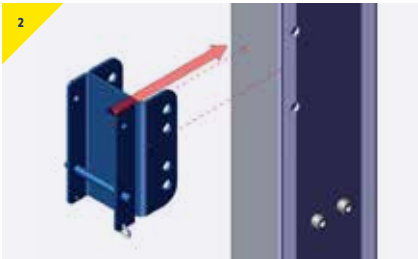

> Present the bracket to the column as shown.

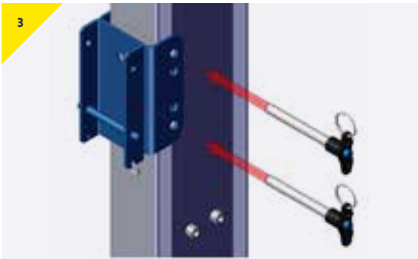

> Secure using the pins provided.

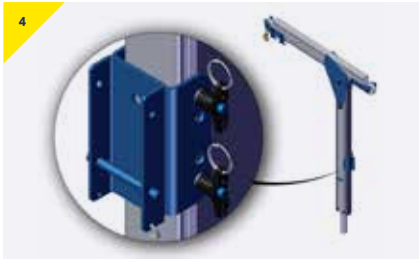

> The bracket is now ready to receive the device.

# > PORTADAVIT 500

The following instructions detail the assembly of the 3M™ DBI-SALA® Ultra-Lok™ bracket [RAWB003003] for the PORTADAVIT 500.

Appropriate PPE should be worn: > Gloves > Protective Footwear



## 3M™ DBI-SALA® Ultra-Lok™ Bracket - [RAWB003003]



1 > Bracket is supplied with pins as shown.

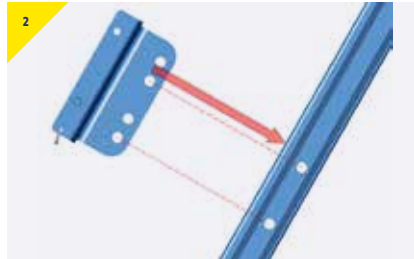

2 > Present the bracket to the backstay as shown.

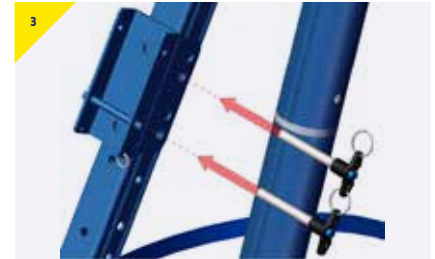

3 > Secure using the pins provided.



4 > The bracket is now ready to receive the device.

# ▶ PORTADAVIT QUANTUM® Column

The following instructions detail the assembly of the 3M™ DBI-SALA® Ultra-Lok™ bracket [RAWB003000] for the PORTADAVIT QUANTUM® column.

**Warning:** For this configuration a sheave bracket column is required.

Appropriate PPE should be worn: ▶ Gloves ▶ Protective Footwear

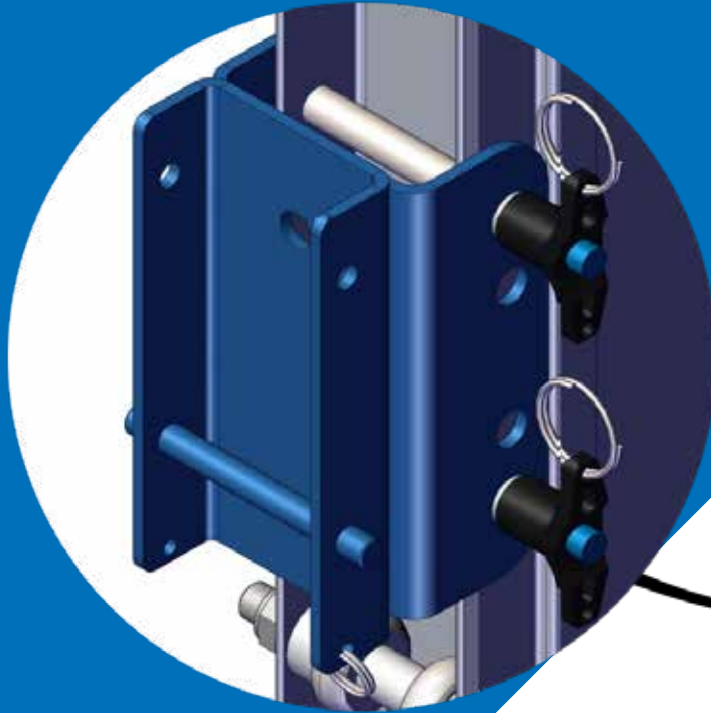

# 3M™ DBI-SALA® Ultra-Lok™ Bracket - [RAWB003000]



1 > Bracket is supplied with pins as shown.

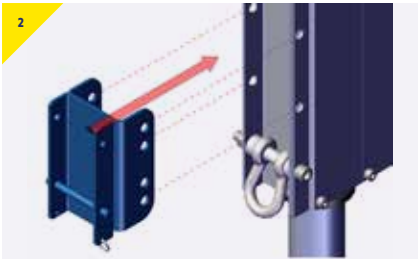

2 > Present the bracket to the column as shown.

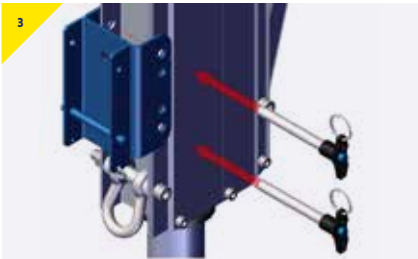

3 > Secure using the pins provided.

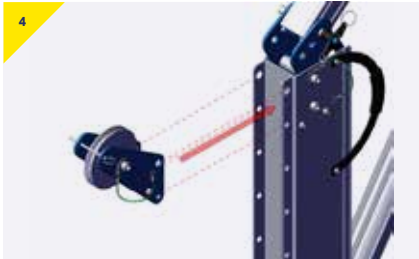

4 > Present the sheave bracket\* to the upper-most holes of the column.



5 > Secure using the pins provided.

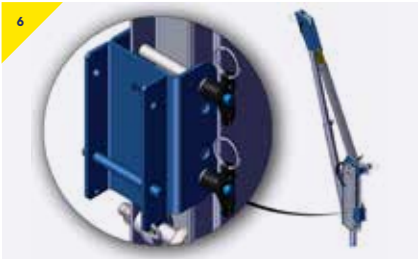

6 > The bracket is now ready to receive the device.

\*RAW000095 - Sheave bracket PDQ Column Medium Sheave (4-7mm).

# ▶ PORTA DAVIT QUANTUM® Backstay Single Winch

The following instructions detail the assembly of the 3M™ DBI-SALA® Ultra-Lok™ bracket [RAWB003000] for the PORTA DAVIT QUANTUM® Backstay.

Appropriate PPE should be worn: ▶ Gloves ▶ Protective Footwear

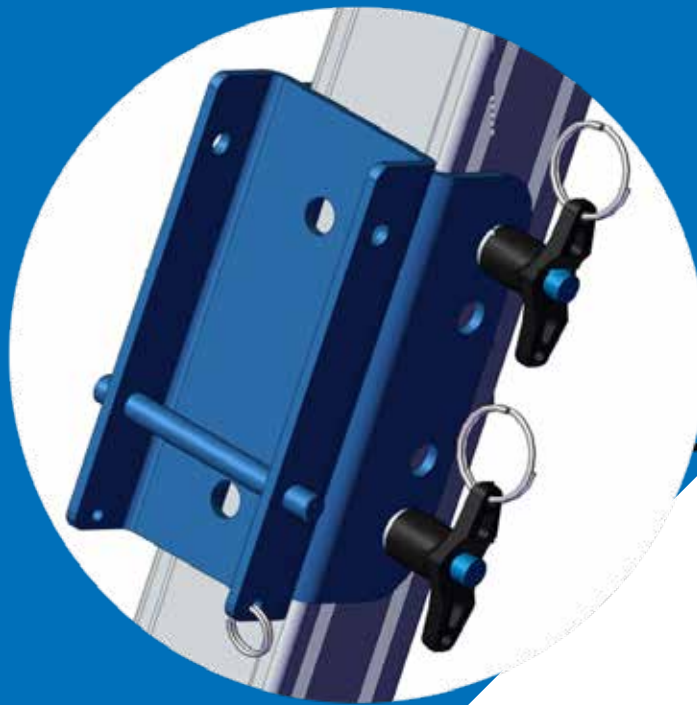

3M™ DBI-SALA® Ultra-Lok™ Bracket - [RAWB003000]



> Bracket is supplied with pins as shown.

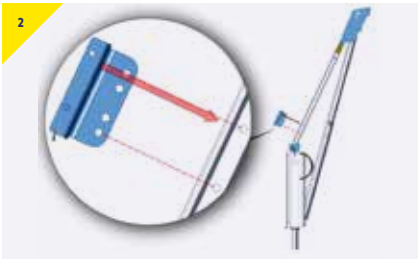

> Present the bracket to the backstay as shown.

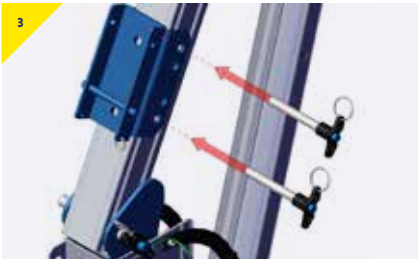

> Secure using the pins provided.

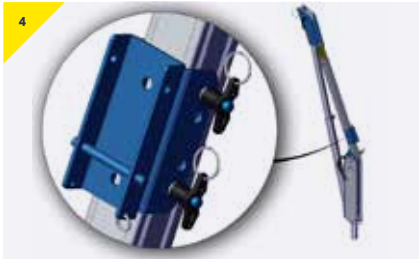

> The bracket is now ready to receive the device.

# ▶ PORTA DAVIT QUANTUM® Backstay Double Winch

The following instructions detail the assembly of the 3M™ DBI-SALA® Ultra-Lok™ bracket [RAWB003010] for the PORTA DAVIT QUANTUM® Backstay.

Appropriate PPE should be worn: ▶ Gloves ▶ Protective Footwear

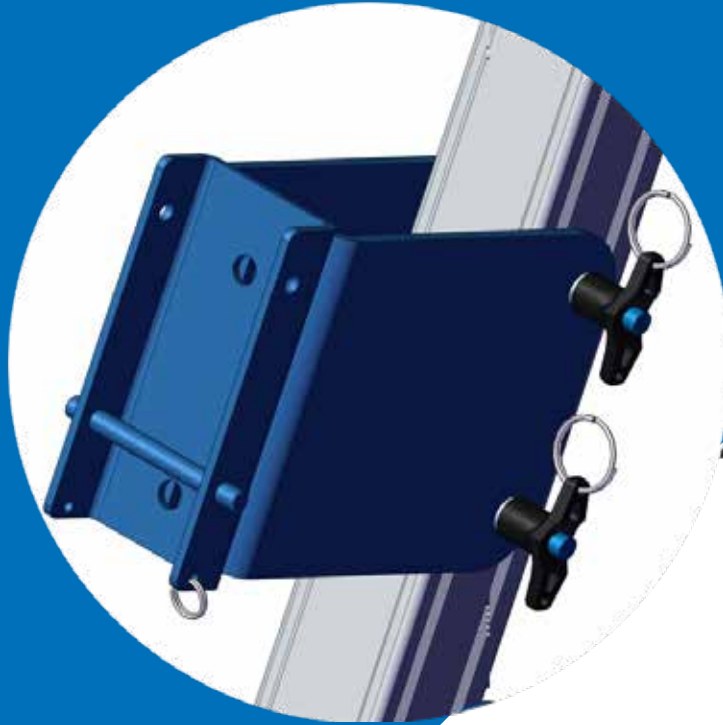



## 3M™ DBI-SALA® Ultra-Lok™ Bracket - [RAWB003010]



1 > Bracket is supplied with pins as shown.

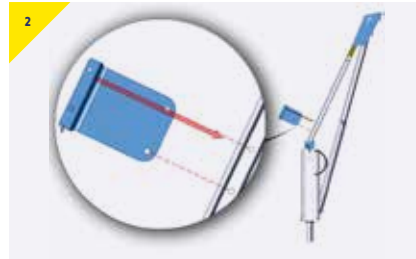

2 > Present the bracket to the backstay as shown.

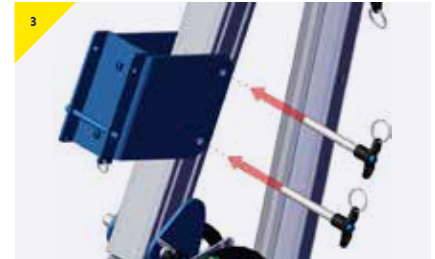

3 > Secure using the pins provided.

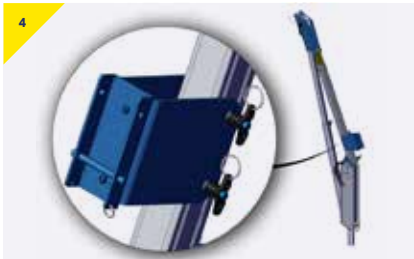

4 > The bracket is now ready to receive the device.

# > PORTX<sup>®</sup> DAVIT

The following instructions detail the assembly of the 3M™ DBI-SALA® Ultra-Lok™ bracket [RAWB003000] for the PORTX<sup>®</sup> DAVIT.

Appropriate PPE should be worn: > Gloves > Protective Footwear

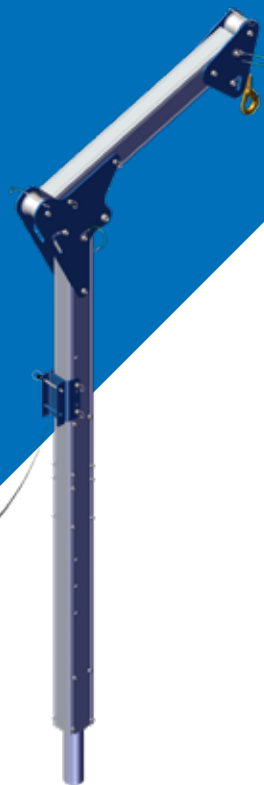
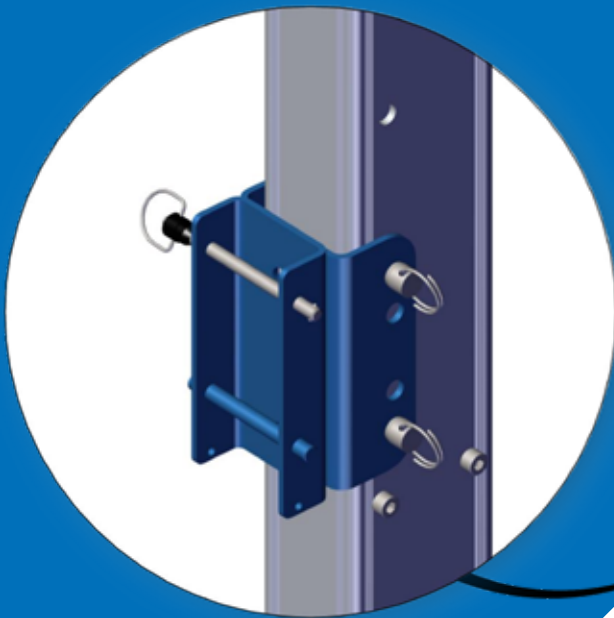

## 3M™ DBI-SALA® Ultra-Lok™ Bracket - [RAWB003000]



> Bracket is supplied with pins as shown.

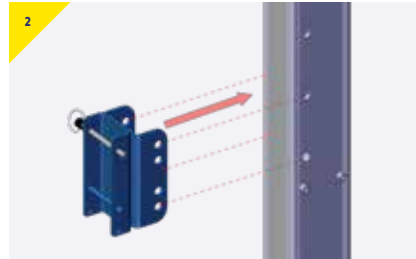

> Present the bracket to the column as shown.

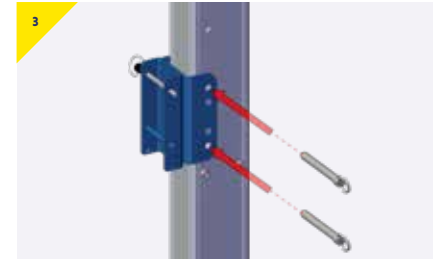

> Secure using the pins provided.

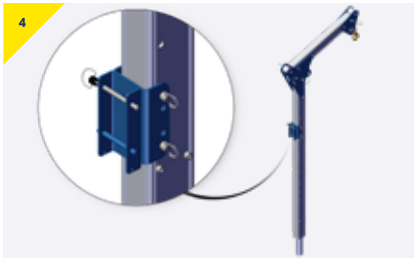

> The bracket is now ready to receive the device.

# Contact Us

## Head Office, UK

Unit 1 Wyeview  
Newhouse Farm Industrial Estate  
Chepstow  
Monmouthshire  
NP16 6UD  
United Kingdom

-  +44 (0)1291 620 796
-  [enquiries@reidlifting.com](mailto:enquiries@reidlifting.com)
-  [www.reidlifting.com](http://www.reidlifting.com)

All information herein is copyright protected by REID Lifting Ltd. All company and product names are Trade Mark and Trade Name protected and all REID Lifting Ltd. Product IPR is protected under Patents, Patents Pending and/or Design Rights.



Printed using environment friendly processes and materials.