



3M™ Rebel® Protecta Bracket

➤ Assembly & Operation Guide

Contents

Fitting device into Bracket - Trap Plates	4
Fitting device into Bracket - Columns	6
PORTA GANTRY <small>RAPIDE</small> 500	8
PORTA GANTRY <small>RAPIDE</small> 1000	10
PORTA GANTRY [®] Small & Medium	12
PORTA GANTRY [®]	14
T DAVIT [®]	16
PORTA DAVIT <small>QUANTUM</small> Column	18
PORTA DAVIT <small>QUANTUM</small> Backstay Single Winch	20
PORTA DAVIT <small>QUANTUM</small> Backstay Double Winch	22
PORTA DAVIT [®] 500	24
PORT X [®] DAVIT	26

Lightweight. Portable. **Safe.**

Please read the following instructions and guidance notes carefully. These have been designed to aid users in carrying out the correct assembly of the bracket for each of our compatible lifting systems. Systems compatible with this product are:

- PORTAGANTRY[®] RAPIDE[™]
- PORTAGANTRY[®]
- TDAVIT[®]
- PORTADAVIT[®] QUANTUM[™]
- PORTADAVIT[®]
- PORTX[®] DAVIT

General Specification

- Maximum rated capacity for fall protection - 1 person
- Ensure the rating of the Winch is always checked before use
- For use with REID lifting products only

Standards

- EN795:2012 Type B
- EN1496:2017

For further information please refer to the technical data sheet for this product.

For operations guide and technical specifications for the device, please refer to the manufacturer's dedicated guide.

➤ Fitting the Device - Trap Plates

The following instructions detail the assembly of the 3M™ Rebel® Protecta device into the bracket on trap plate attachments.



Appropriate PPE should be worn: ➤ Gloves ➤ Protective Footwear

3M™ Rebel® Protecta Bracket

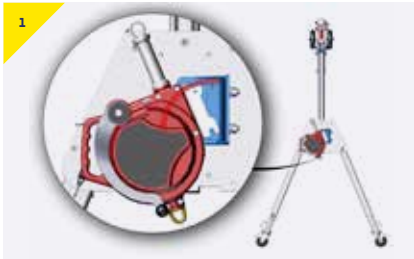

1 > Present the device to the bracket.



2 > Insert the pin provided to secure the device.



3 > Secure the pin using the R-clip provided.



4 > Device is secure and ready to use.

➤ Fitting the Device - Columns

The following instructions detail the assembly of the 3M™ Rebel® Protecta device into the bracket.



Appropriate PPE should be worn: ➤ Gloves ➤ Protective Footwear

3M™ Rebel® Protecta Bracket

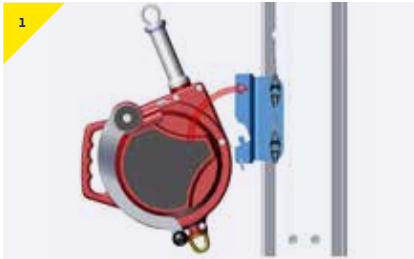

> Present the device to the bracket.

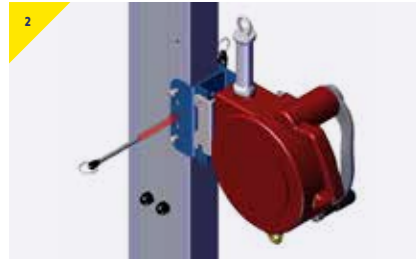

> Insert the pin provided to secure the device.



> Device is secure and ready to use.

▶ PORTAGANTRY **RAPIDE**® 500

The following instructions detail the assembly of the 3M™ Rebel® Protecta bracket [RAWB003520] for the **PORTAGANTRY **RAPIDE**® 500kg**.

Appropriate PPE should be worn: ▶ **Gloves** ▶ **Protective Footwear**

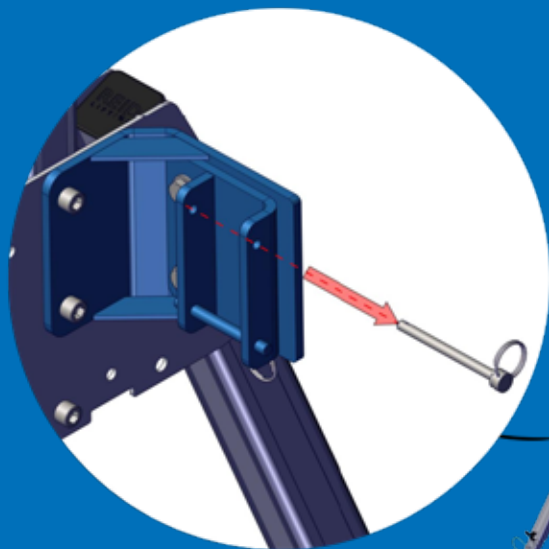

3M™ Rebel® Protecta Bracket - [RAWB003520]

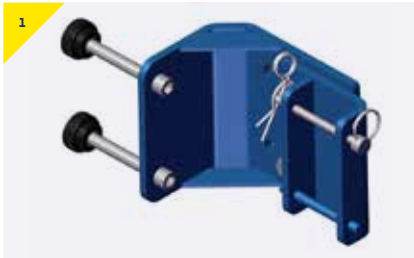

> Bracket is supplied with bolts and pins as shown.

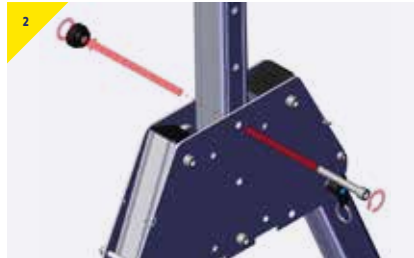

> Remove the top bolt from the trap plate.

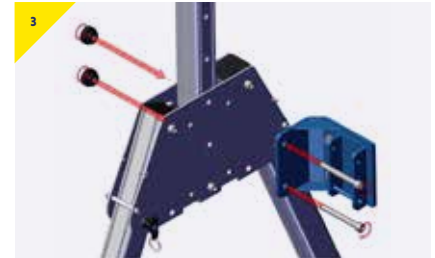

> Present the bracket to the trap plate, securing using the M12 bolts supplied.



> The bracket is now ready to receive the device.

▶ PORTAGANTRY **RAPIDE**® 1000

The following instructions detail the assembly of the 3M™ Rebel® Protecta bracket [RAWB003520] for the **PORTAGANTRY **RAPIDE** 1000kg**.

Appropriate PPE should be worn: ▶ Gloves ▶ Protective Footwear

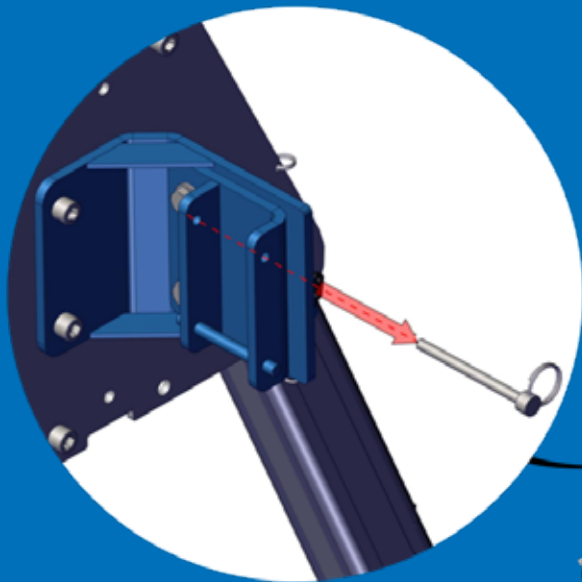

3M™ Rebel® Protecta Bracket - [RAWB003520]

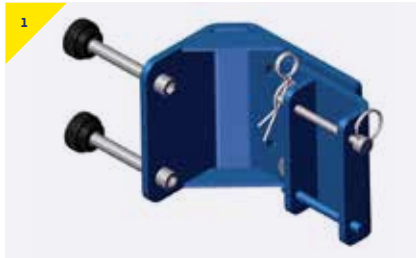

➤ Bracket is supplied with bolts and pins as shown.

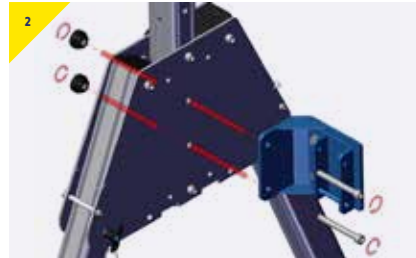

➤ Present the bracket to the trap plate, securing using the M12 bolts supplied.



➤ The bracket is now ready to receive the device.

▶ PORTAGANTRY® Small & Medium

The following instructions detail the assembly of the 3M™ Rebel® Protecta bracket [RAWB003522] for the PORTAGANTRY® Small and Medium frame sizes.

Appropriate PPE should be worn: ▶ Gloves ▶ Protective Footwear

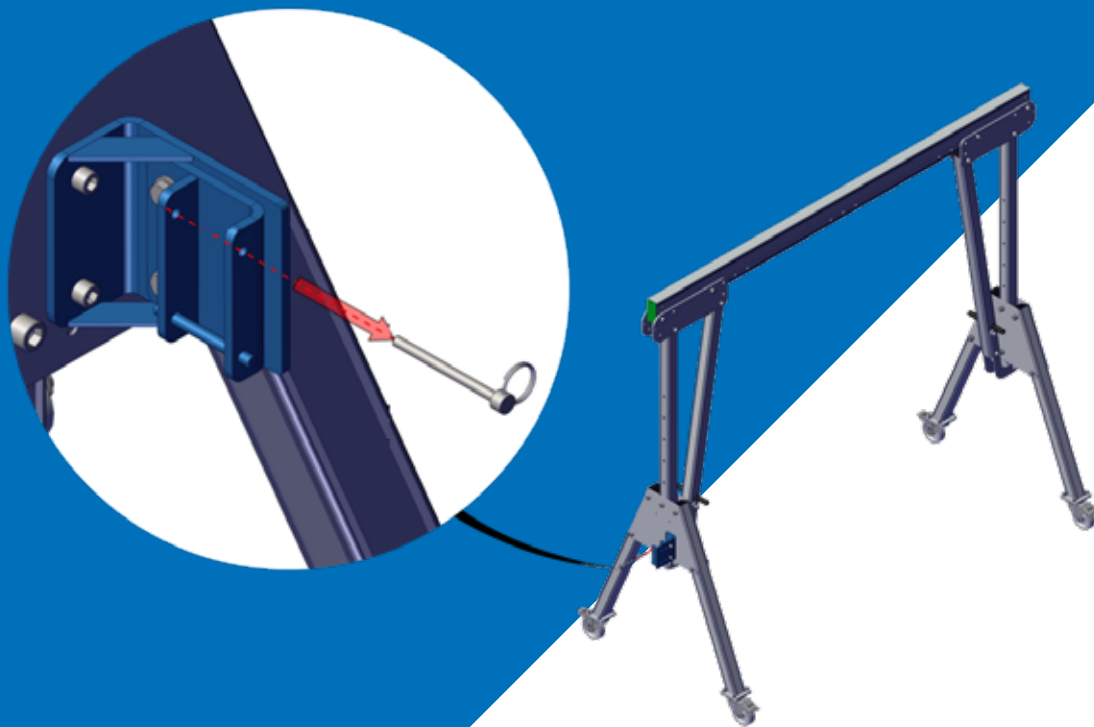

3M™ Rebel® Protecta Bracket - [RAWB003522]

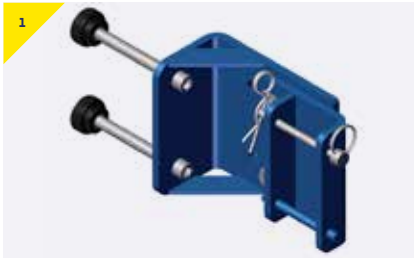

➤ Bracket is supplied with bolts and pins as shown.

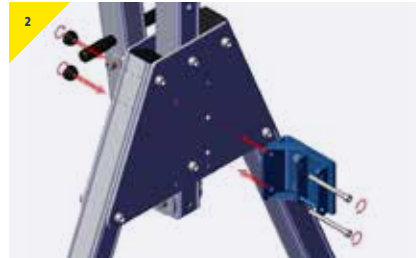

➤ Present the bracket to the trap plate, securing using the M12 bolts supplied.



➤ The bracket is now ready to receive the device.

> PORTAGANTRY®

The following instructions detail the assembly of the 3M™ Rebel® Protecta bracket [RAWB003000] for the PORTAGANTRY®.

Appropriate PPE should be worn: > Gloves > Protective Footwear



3M™ Rebel® Protecta Bracket - [RAWB003000]



1 > Bracket is supplied with pins as shown.

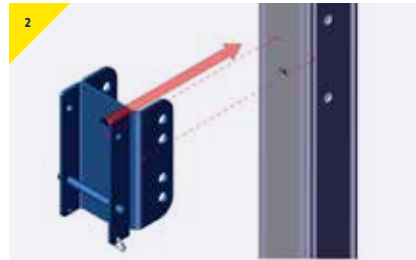

2 > Present the bracket to the column as shown.

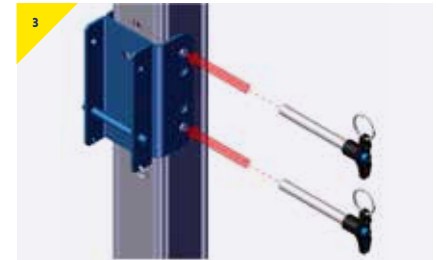

3 > Secure using the pins provided.



4 > The bracket is now ready to receive the device.



The following instructions detail the assembly of the 3M™ Rebel® Protecta bracket [RAWB003000] for the TDAVIT.

Appropriate PPE should be worn: [Gloves](#) [Protective Footwear](#)

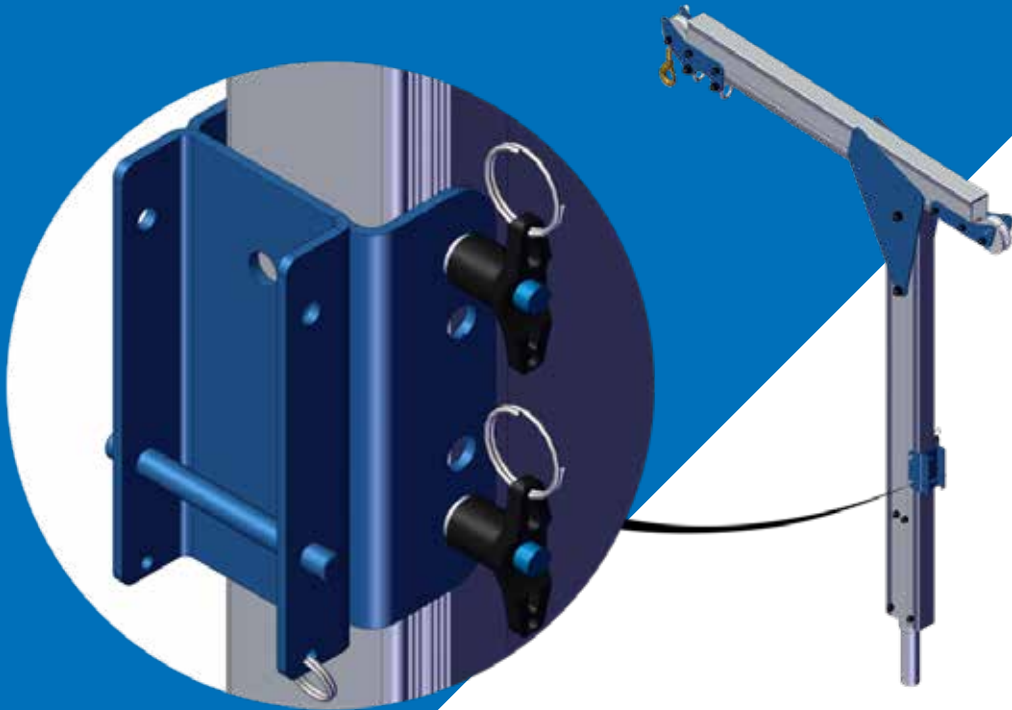

3M™ Rebel® Protecta Bracket - [RAWB003000]



➤ Bracket is supplied with pins as shown.

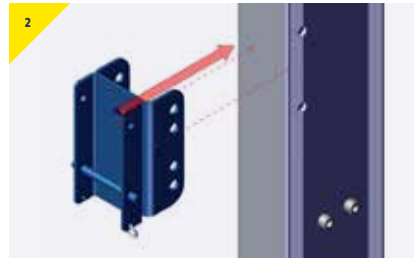

➤ Present the bracket to the column as shown.

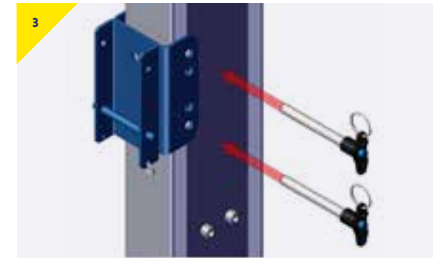

➤ Secure using the pins provided.



➤ The bracket is now ready to receive the device.

> PORTADAVIT 500

The following instructions detail the assembly of the 3M™ Rebel® Protecta bracket [RAWB003003] for the PORTADAVIT 500.

Appropriate PPE should be worn: > Gloves > Protective Footwear



3M™ Rebel® Protecta Bracket - [RAWB003003]



1 > Bracket is supplied with pins as shown.

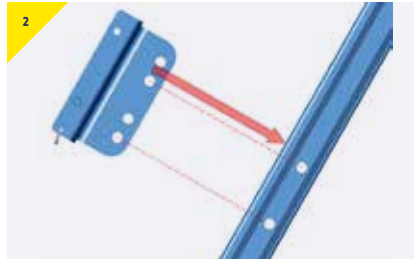

2 > Present the bracket to the backstay as shown.

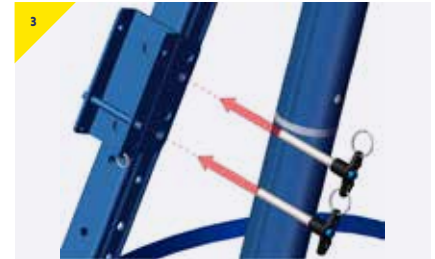

3 > Secure using the pins provided.

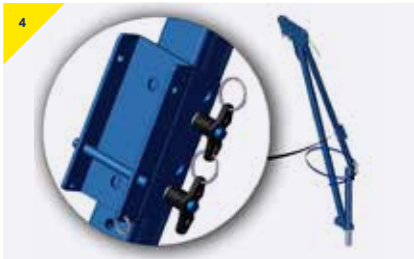

4 > The bracket is now ready to receive the device.

▶ PORTADAVIT QUANTUM® Column

The following instructions detail the assembly of the 3M™ Rebel® Protecta bracket [RAWB003000] for the PORTADAVIT QUANTUM® column.
Warning: For this configuration a sheave bracket column is required.

Appropriate PPE should be worn: ▶ Gloves ▶ Protective Footwear

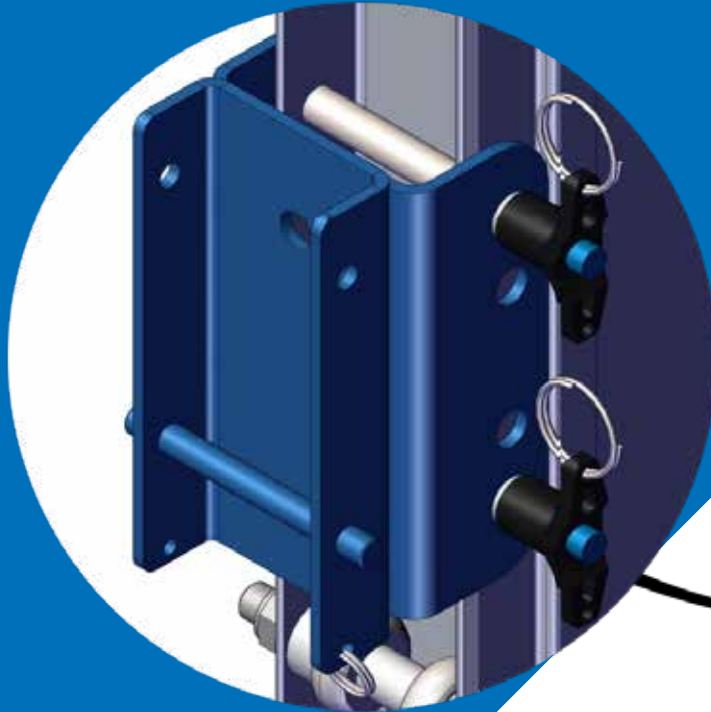

3M™ Rebel® Protecta Bracket - [RAWB003000]



1 > Bracket is supplied with pins as shown.

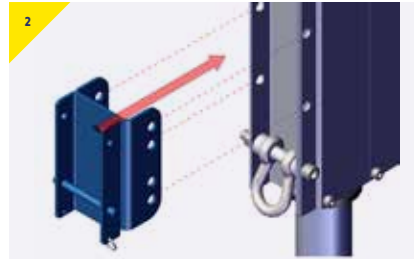

2 > Present the bracket to the column as shown.

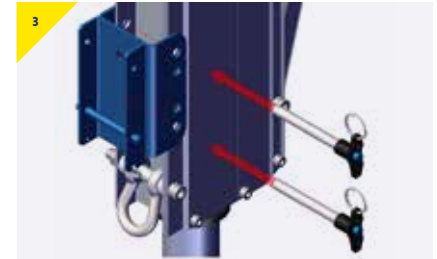

3 > Secure using the pins provided.

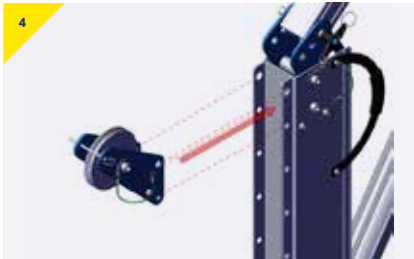

4 > Present the sheave bracket* to the upper-most holes of the column.



5 > Secure using the pins provided.



6 > The bracket is now ready to receive the device.

*RAW000095 - Sheave bracket PDQ Column
Medium Sheave (4-7mm).

▶ PORTADAVIT QUANTUM® Backstay Single Winch

The following instructions detail the assembly of the 3M™ Rebel® Protecta bracket [RAWB003000] for the PORTADAVIT QUANTUM® Backstay.

Appropriate PPE should be worn: ▶ Gloves ▶ Protective Footwear

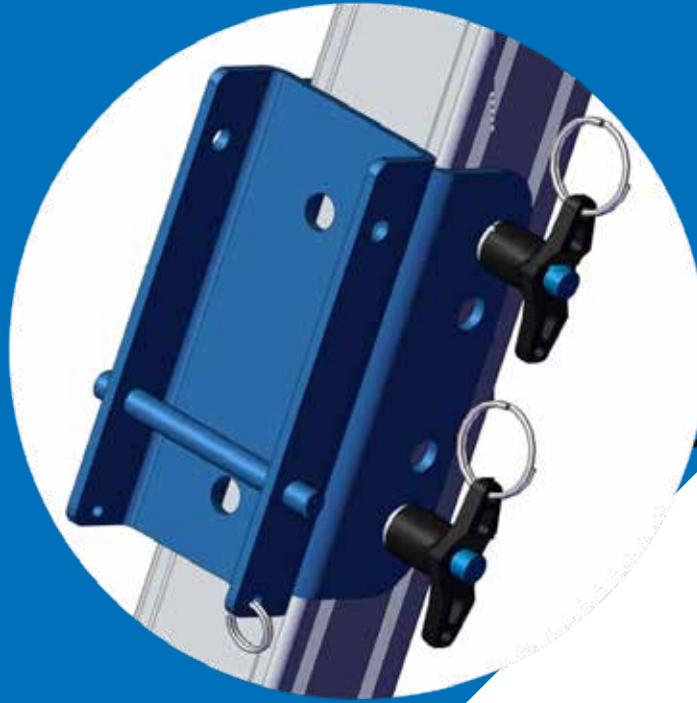

3M™ Rebel® Protecta Bracket - [RAWB003000]



1 > Bracket is supplied with pins as shown.

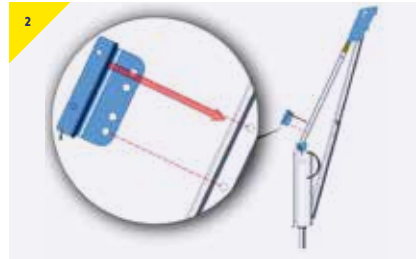

2 > Present the bracket to the backstay as shown.

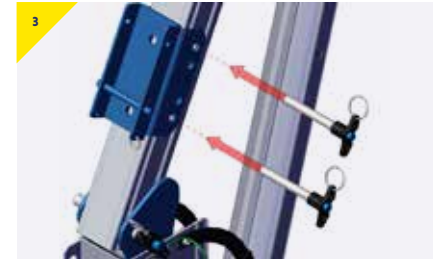

3 > Secure using the pins provided.

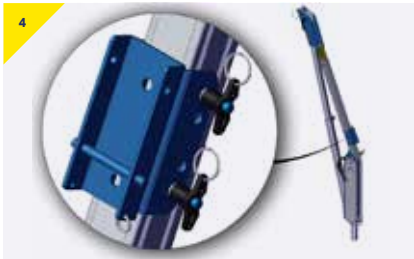

4 > The bracket is now ready to receive the device.

▶ PORTA DAVIT QUANTUM® Backstay Double Winch

The following instructions detail the assembly of the 3M™ Rebel® Protecta bracket [RAWB003010] for the PORTA DAVIT QUANTUM® Backstay.

Appropriate PPE should be worn: ▶ Gloves ▶ Protective Footwear



3M™ Rebel® Protecta Bracket - [RAWB003010]



➤ Bracket is supplied with pins as shown.

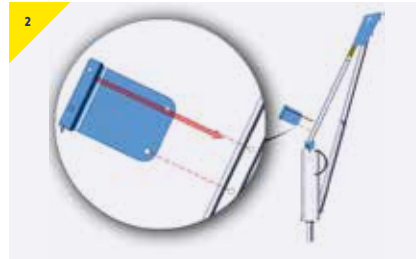

➤ Present the bracket to the backstay as shown.

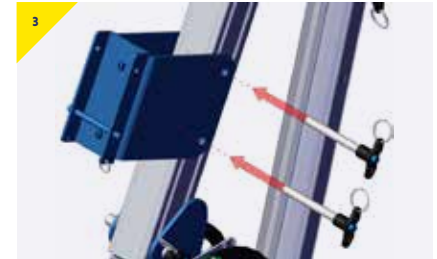

➤ Secure using the pins provided.

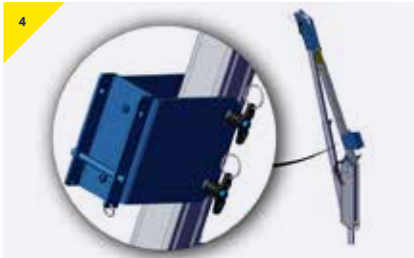

➤ The bracket is now ready to receive the device.

> PORTX[®] DAVIT

The following instructions detail the assembly of the 3M[™] Rebel[®] Protecta bracket [RAWB003000] for the PORTX[®] DAVIT.

Appropriate PPE should be worn: > Gloves > Protective Footwear

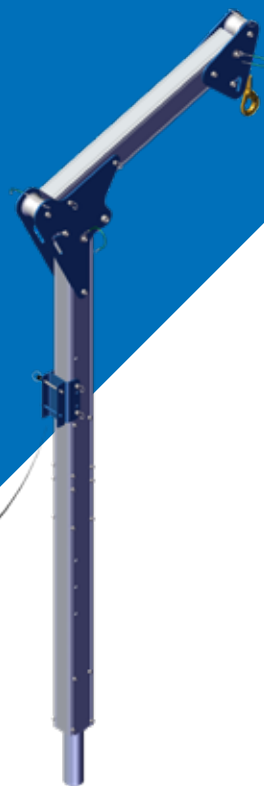
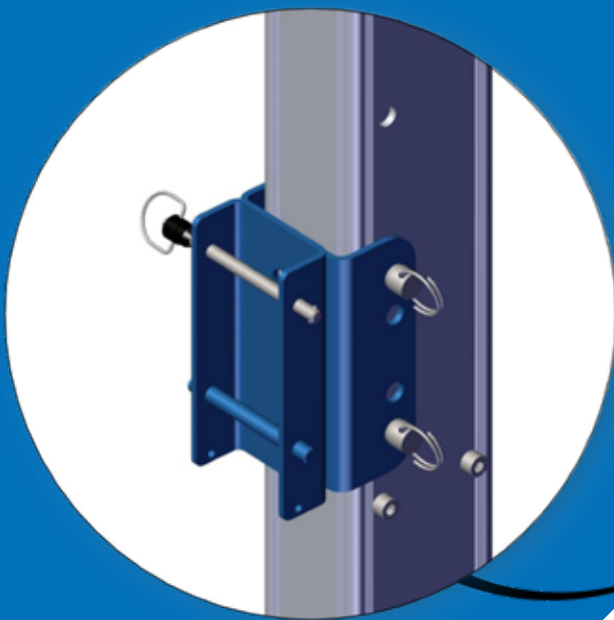

3M™ Rebel® Protecta Bracket - [RAWB003000]



> Bracket is supplied with pins as shown.

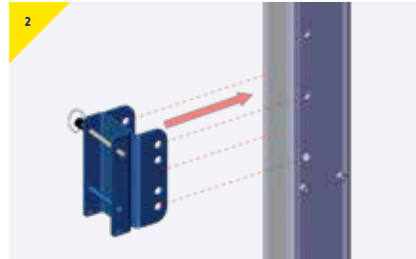

> Present the bracket to the column as shown.

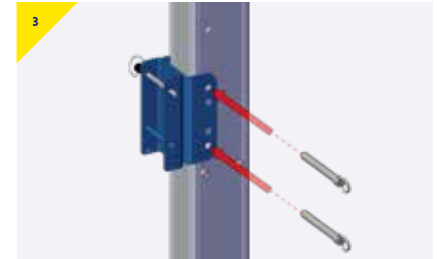

> Secure using the pins provided.

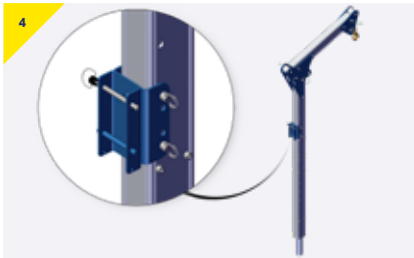

> The bracket is now ready to receive the device.

Contact Us

Head Office, UK

Unit 1 Wyeview
Newhouse Farm Industrial Estate
Chepstow
Monmouthshire
NP16 6UD
United Kingdom

-  +44 (0)1291 620 796
-  enquiries@reidlifting.com
-  www.reidlifting.com

All information herein is copyright protected by REID Lifting Ltd. All company and product names are Trade Mark and Trade Name protected and all REID Lifting Ltd. Product IPR is protected under Patents, Patents Pending and/or Design Rights.



Printed using environment friendly processes and materials.