



Guardian FABXR Bracket

➤ Assembly & Operation Guide

Contents

Fitting device into Bracket	4
PORTA GANTRY <small>[RAPIDE]</small> 500	6
PORTA GANTRY <small>[RAPIDE]</small> 1000	8
PORTA GANTRY [®] Small & Medium	10
PORTA GANTRY [®]	14
T DAVIT [®]	16
PORTA DAVIT <small>[QUANTUM]</small> Column	18
PORTA DAVIT <small>[QUANTUM]</small> Backstay Single Winch	20
PORTA DAVIT <small>[QUANTUM]</small> Backstay Double Winch	22
PORTA DAVIT [®] 500	24
PORTX [®] DAVIT	26

Lightweight. Portable. **Safe.**

Please read the following instructions and guidance notes carefully. These have been designed to aid users in carrying out the correct assembly of the bracket for each of our compatible lifting systems. Systems compatible with this product are:

- PORTAGANTRY^[RAPIDE]
- PORTAGANTRY^{*}
- TDAVIT^{*}
- PORTADAVIT^[QUANTUM]
- PORTADAVIT^{*}
- PORTX[®] DAVIT

General Specification

- Maximum rated capacity for fall protection - 1 person
- Ensure the rating of the Winch is always checked before use
- For use with REID lifting products only

Standards

- EN795:2012 Type B
- EN1496:2017

For further information please refer to the technical data sheet for this product.

For operations guide and technical specifications for the device, please refer to the manufacturer's dedicated guide.

➤ Fitting the Device

The following instructions detail the assembly of the Guardian FABXR device into the bracket on trap plate attachments.



Appropriate PPE should be worn: ➤ **Gloves** ➤ **Protective Footwear**

1

Prepare the bracket to receive the device by removing the bolt from bottom connector and loosen off the top connector.

2



➤ Present the device to the bracket.

3

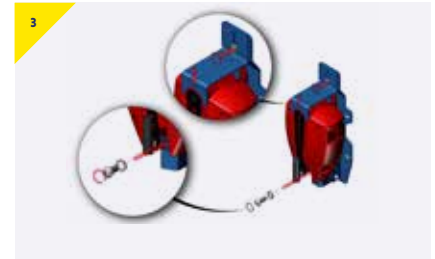

➤ Secure the Device by reinserting the bottom bolt to the connector. Tighten the top connector into a secure position.

4



➤ The device is now secure and ready to use.

▶ PORTAGANTRY RAPIDE® 500

The following instructions detail the assembly of the Guardian FABXR bracket [RAWB001020] for the PORTAGANTRY RAPIDE® 500kg.

Appropriate PPE should be worn: ▶ Gloves ▶ Protective Footwear

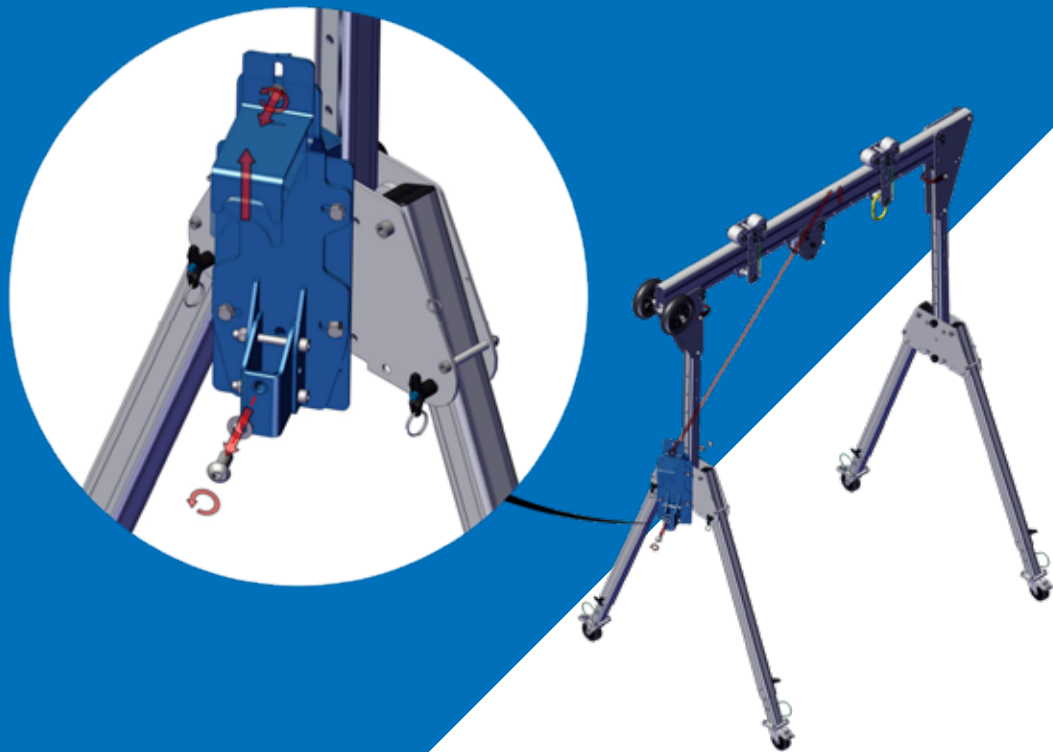

Guardian FABXR Bracket - [RAWB001020]



- Bracket is supplied with bolts and pins as shown.



- Remove the bottom bolt from the trap plate and loosen the top bolt - **do not fully remove**.



- Present the bracket to the trap plate, slotting the keyhole slot onto the loosened bolt. Once locked on, tighten the bolt.



- Insert and secure the tommy screw into the bottom hole.



- The bracket is now ready to receive the device.

▶ PORTAGANTRY **RAPIDE**® 1000

The following instructions detail the assembly of the Guardian FABXR bracket [RAWB001020] for the **PORTAGANTRY **RAPIDE**® 1000kg**.

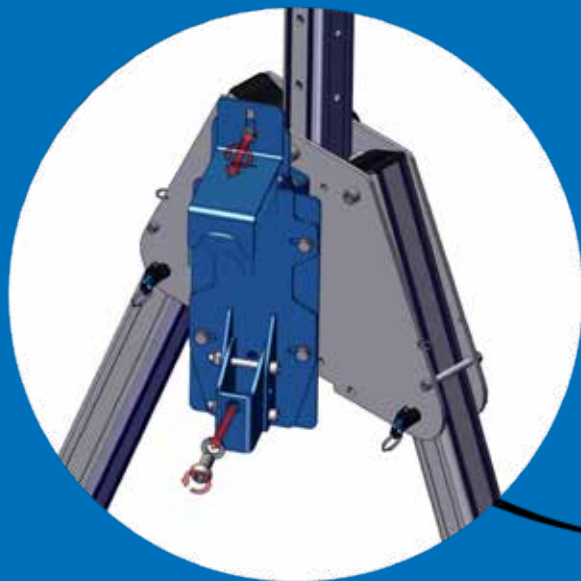

Appropriate PPE should be worn: ▶ Gloves ▶ Protective Footwear

Guardian FABXR Bracket - [RAWB001020]



- Bracket is supplied with bolts and pins as shown.



- Remove the bottom bolt from the trap plate and loosen the top bolt - **do not fully remove**.

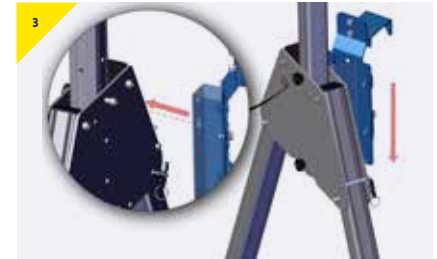

- Present the bracket to the trap plate, slotting the keyhole slot onto the loosened bolt. Once locked on, tighten the bolt.

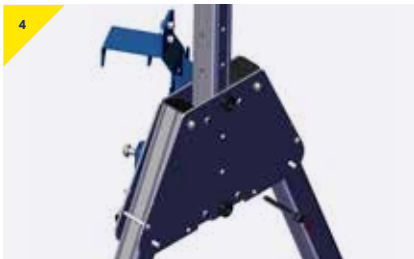

- Insert and secure the tommy screw into the bottom hole.



- The bracket is now ready to receive the device.

▶ PORTAGANTRY® Small & Medium

The following instructions detail the assembly of the Guardian FABXR bracket [RAWB001020] for the **PORTAGANTRY®** Small and Medium frame sizes.

Appropriate PPE should be worn: ▶ Gloves ▶ Protective Footwear

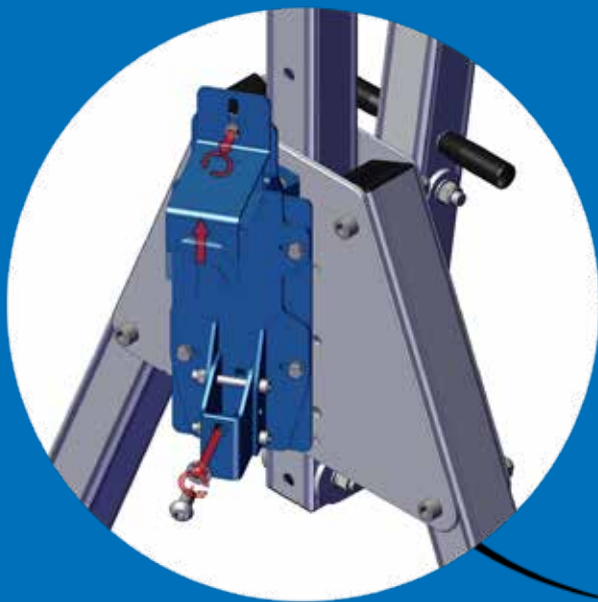

Guardian FABXR Bracket - [RAWB001020]



1 > Bracket is supplied with bolts and pins as shown.



2 > Disassemble the bracket, separating the back plate from the faceplate.

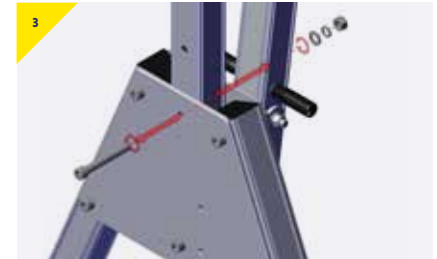

3 > Remove top bolt from trap plate.

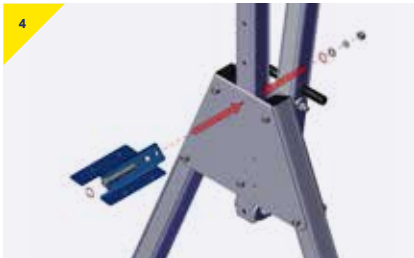

4 > Present the bracket to the trap plate, securing using the M16 bolt provided.

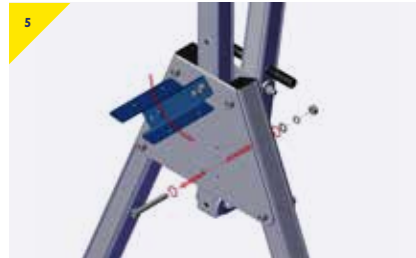

5 > Remove the bottom bolt from the trap plate.

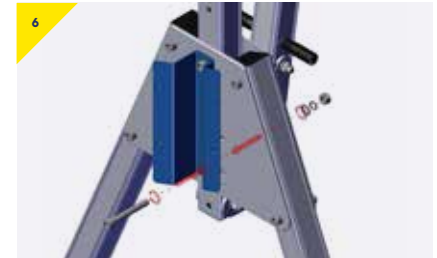

6 > Carefully align the backplate and secure into the bottom hole on the trap plate using the M16 bolt provided.

▶ PORTAGANTRY® Small & Medium



▶ Reassemble the bracket using all bolts.



▶ The bracket is now ready to receive the device.

> PORTAGANTRY®

The following instructions detail the assembly of the Guardian FABXR bracket [RAWB001000] for the PORTAGANTRY®.

Appropriate PPE should be worn: > Gloves > Protective Footwear



Guardian FABXR Bracket - [RAWB001000]



- Bracket is supplied with pins as shown.

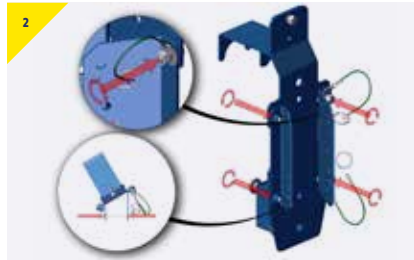

- Adjust the width of the wings to 76.2mm to fit comfortably on the column.



- Present the bracket to the column as shown.

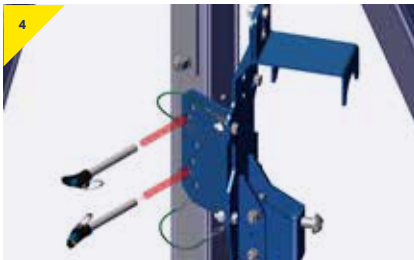

- Secure using the pins provided.



- The bracket is now ready to receive the device.



The following instructions detail the assembly of the Guardian FABXR bracket [RAWB001000] for the TDAVIT.

Appropriate PPE should be worn: [Gloves](#) [Protective Footwear](#)

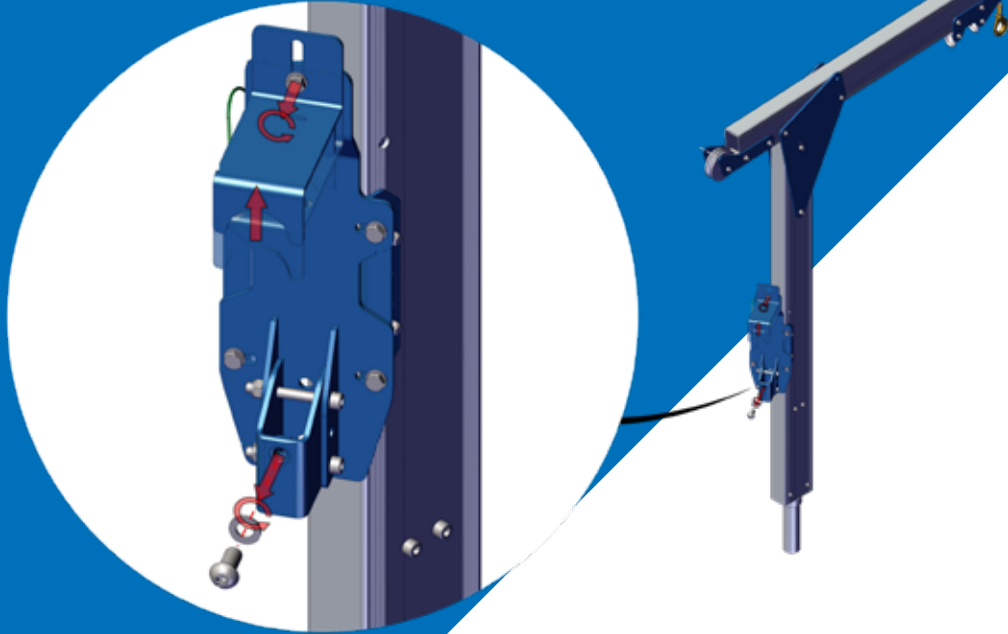

Guardian FABXR Bracket - [RAWB001000]



➤ Bracket is supplied with pins as shown.

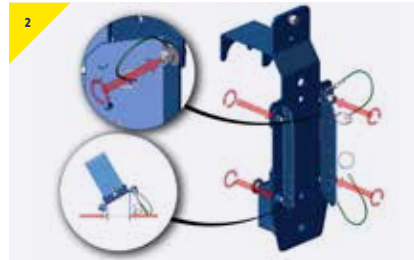

➤ Adjust the width of the wings to 76.2mm to fit comfortably on the column.



➤ Present the bracket to the column as shown.



➤ Secure using the pins provided.



➤ The bracket is now ready to receive the device.

▶ PORTADAVIT 500

The following instructions detail the assembly of the Guardian FABXR bracket [RAWB001000] for the PORTADAVIT 500.

Appropriate PPE should be worn: ▶ Gloves ▶ Protective Footwear



Guardian FABXR Bracket - [RAWB001000]



- Bracket is supplied with pins as shown.

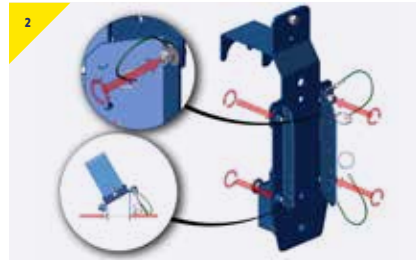

- Adjust the width of the wings to 50.8mm to fit comfortably on the backstay.

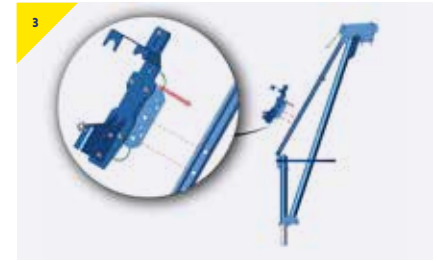

- Present the bracket to the backstay as shown.



- Secure using the pins provided.



- The bracket is now ready to receive the device.

▶ PORTADAVIT QUANTUM® Column

The following instructions detail the assembly of the Guardian FABXR bracket [RAWB001000] for the PORTADAVIT QUANTUM® column.

Warning: For this configuration a sheave bracket column is required.



Appropriate PPE should be worn: ▶ Gloves ▶ Protective Footwear

Guardian FABXR Bracket - [RAWB001000]



- Bracket is supplied with pins as shown.

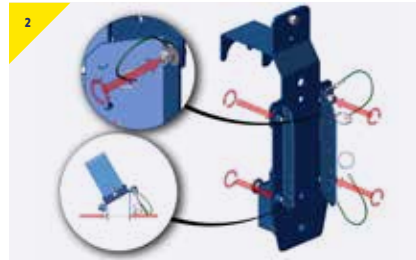

- Adjust the width of the wings to 76.2mm to fit comfortably on the column.

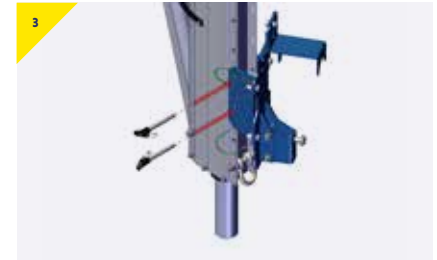

- Present the bracket to the column and secure using the pins provided.

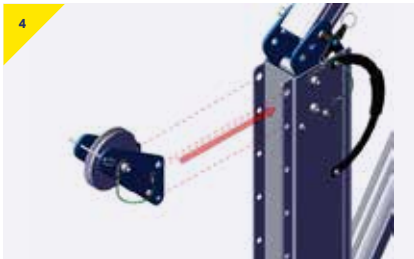

- Present the sheave bracket* to the upper-most holes of the column.



- Secure using the pins provided.



- The bracket is now ready to receive the device.

*RAW000095 - Sheave bracket PDQ Column
Medium Sheave (4-7mm).

▶ PORTA DAVIT QUANTUM® Backstay Single Winch

The following instructions detail the assembly of the Guardian FABXR bracket [RAWB001000] for the PORTA DAVIT QUANTUM® Backstay.

Appropriate PPE should be worn: ▶ Gloves ▶ Protective Footwear

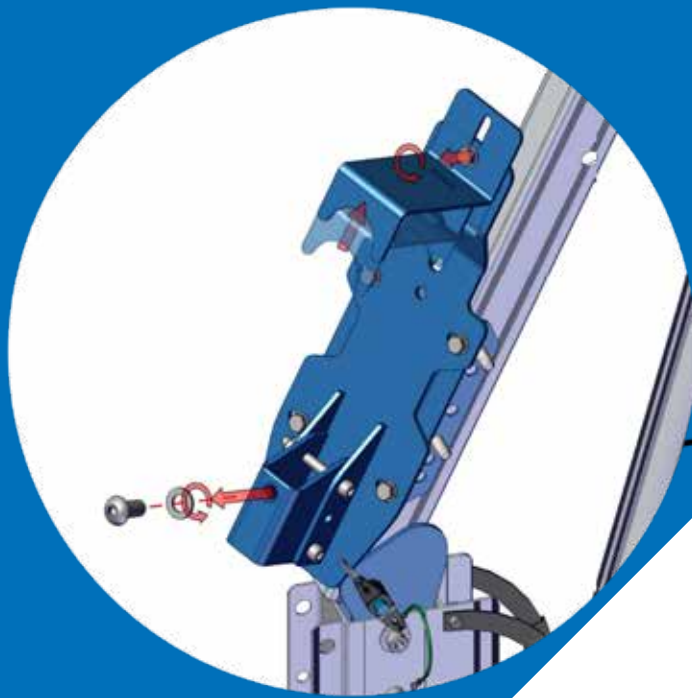

Guardian FABXR Bracket - [RAWB001000]



- Bracket is supplied with pins as shown.

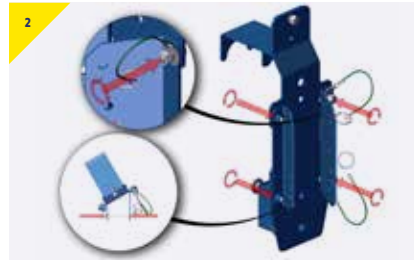

- Adjust the width of the wings to 63.5mm to fit comfortably on the backstay.



- Present the bracket to the backstay as shown.



- Secure using the pins provided.



- The bracket is now ready to receive the device.

▶ PORTADAVIT QUANTUM® Backstay Double Winch

The following instructions detail the assembly of the Guardian FABXR bracket [RAWB001010] for the PORTADAVIT QUANTUM® Backstay.

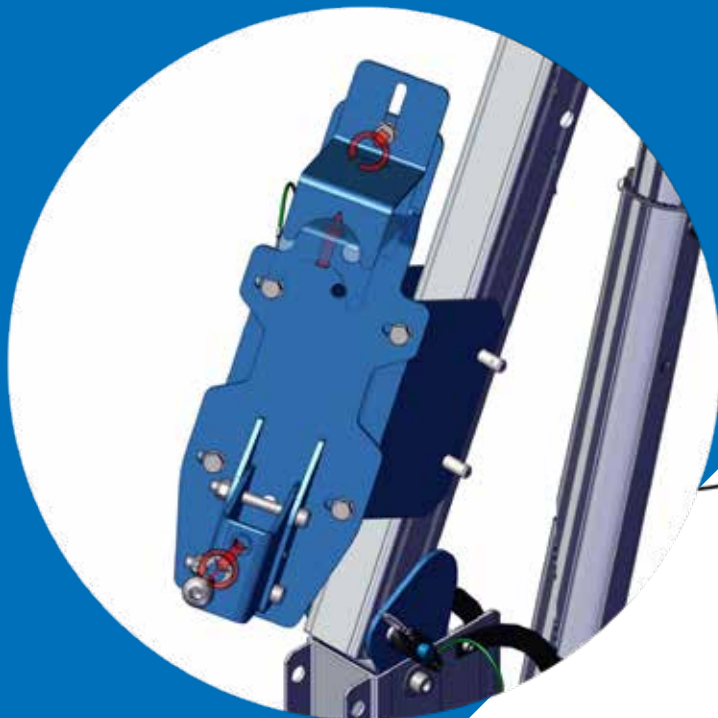

Appropriate PPE should be worn: ▶ Gloves ▶ Protective Footwear

Guardian FABXR Bracket - [RAWB001010]



- Bracket is supplied with pins as shown.



- Adjust the width of the wings to 63.5mm to fit comfortably on the backstay.



- Present the bracket to the backstay as shown.



- Secure using the pins provided.



- The bracket is now ready to receive the device.

▶ PORTX® DAVIT

The following instructions detail the assembly of the Guardian FABXR bracket [RAWB001000] for the PORTX® DAVIT.

Appropriate PPE should be worn: ▶ Gloves ▶ Protective Footwear

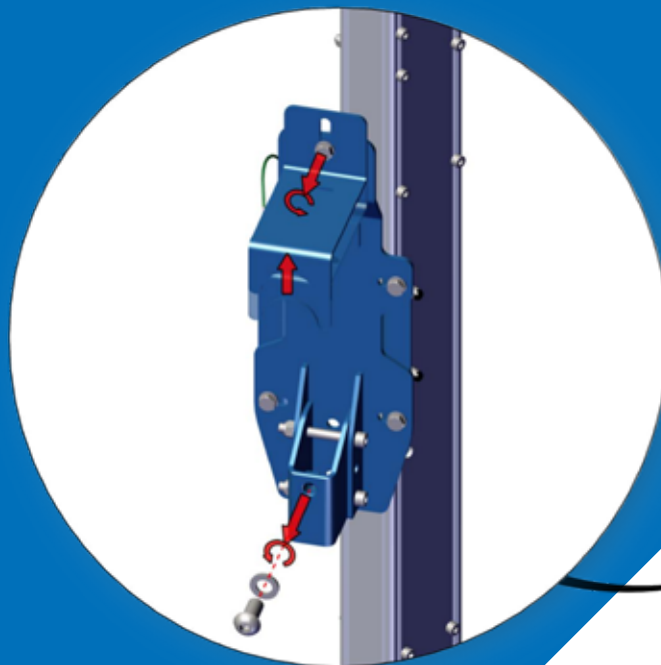

Guardian FABXR Bracket - [RAWB001000]



- Bracket is supplied with pins as shown.

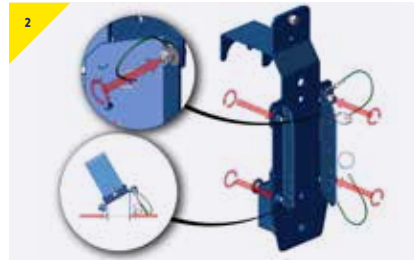

- Adjust the width of the wings to 76.2mm to fit comfortably on the column.

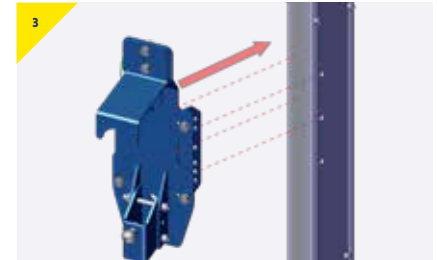

- Present the bracket to the column as shown.

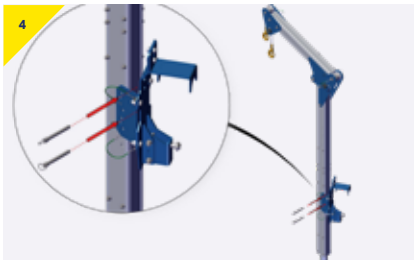

- Secure using the pins provided.

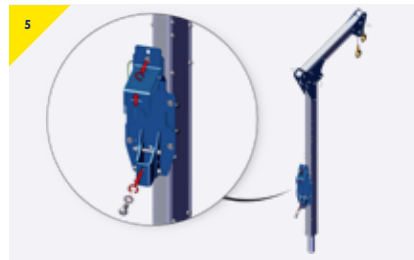

- The bracket is now ready to receive the device.

Contact Us

Head Office, UK

Unit 1 Wyeview
Newhouse Farm Industrial Estate
Chepstow
Monmouthshire
NP16 6UD
United Kingdom

-  +44 (0)1291 620 796
-  enquiries@reidlifting.com
-  www.reidlifting.com

All information herein is copyright protected by REID Lifting Ltd. All company and product names are Trade Mark and Trade Name protected and all REID Lifting Ltd. Product IPR is protected under Patents, Patents Pending and/or Design Rights.



Printed using environment friendly processes and materials.