

# PORTX<sup>®</sup> DAVIT

➤ Assembly & Operation Guide

# Contents

## **Correct Operation** 4

- Intended Use
- Inspection Prior to Initial Operation
- Inspection Before Starting Work
- Maximum Capacity
- Temperature Range
- Notes for Correct Operation
- Disclaimer
- Warning
- Fall Protection
- Additional Notes for Correct Operation & Warnings

## **Inspection & Maintenance** 8

- Regular Inspections
- Maintenance & Repair
- Storage & Transportation

## **Sockets, Installation & Verification** 10

- Sockets
- Socket Installation
- Minimum Mounting Requirements
- Verifying the Installation

## **Fall Protection Applications** 12

## **ATEX** 13

- ATEX
- ExVeritas Certification
- Classification [Zone 2]
- Classification [Zone 1]
- Spark Formation
- Static Electricity
- Inspection, Maintenance & Repair

## **Assembly Instructions** 16

- Double Winch
- Single Winch

## **Dimensions** 23

## **Quality & Safety** 24

- Regulations, Standards & Directives
- Accreditations
- Conformité Européenne [CE] & UK Conformity Assessed [UKCA]
- Testing
- Language
- Product IPR

## **Product Labelling** 26

## **Inspection Record** 28

# Lightweight. Portable. **Safe.**

Please read the following instructions and guidance notes carefully, before using or operating the system.

They contain important information about how to handle and use the system in a safe and efficient way, avoiding danger, reducing repair costs and downtime, and increasing the reliability and lifespan of the system.

They apply for:

- Operation, including preparation, troubleshooting during operation and cleaning
- Maintenance, inspection, repair
- Transportation

It is the responsibility of the end user to adhere to the Health & Safety and accident prevention standards and legislation valid in their respective countries and any regions in which the system is being used. It is also incumbent on the user or competent person to ensure that anyone working with the equipment has the necessary medical and physical capabilities. A rescue plan also needs to be in place in the event of an emergency that could occur during the work. This document should form part of the overriding Risk Assessment and Method Statement required for each lift.

# ➤ Correct Operation

## Intended Use

This product is intended to be used for; the lifting of goods, or the lifting of personnel and as a fall protection anchor point.

This product also provides a secondary safety anchor point on the column for the prevention of falls of the person operating the davit only.

It is expected that all users of this product have the necessary medical and physical capabilities, are fully trained and competent in its safe assembly and use.

## Inspection Prior to Initial Operation

Each product must be inspected prior to initial operation by a competent person to ensure that the structure is safe and that it has not been damaged by incorrect assembly, transport or storage.

## Inspection Before Starting Work

Before starting work, the product assembly and all load-bearing components should be checked for visual defects as per the inspection checklist on page 8.

## Maximum Capacity

**Goods Lifting:** This product is designed to lift and lower loads up to its rated capacity. Do not exceed the capacity indicated on the product.

**Personnel Lifting:** When lifting people, the overall load limit is reduced by half to provide an increased safety factor. The maximum capacity permitted by the personnel winch/accessory used in conjunction with the product also needs to be taken into account.

If this product is to be used for lifting or lowering a person where there is a risk of a fall, then a personal fall arrest system (PFAS) is required, which meets the requirements of prevailing national standards.

If using a lifting device which is attached to the shackle point at the end of the davit arm for the purpose of raising or lowering materials, then the weight of the lifting device should be deducted from the Working Load Limit of the davit.

Please be aware that the maximum radius is achieved when the davit is being used at approximately 75% of its maximum capacity.

## Temperature Range

This product can be operated in ambient dry temperatures between -23° to +55°C (-10°F to 131°F). Consult your supplier in case of extreme working conditions. If used in sub-zero and wet conditions, fall arrest appliances characteristics may change.

## Notes for Correct Operation

- › If using the davit for lifting operations we recommend the use of load-sensing or overload protection devices
- › The risk assessment and method statement must consider any factors that might apply additional loading to the system during lifting operations
- › Suitable, appropriately rated winches and connection plates must be used for all applications
- › Take care when transporting and storing the system to avoid damage
- › Assemble only as instructed (ensure all bolts are present and fitted correctly as per instructions)
- › We recommend that gloves are worn when using the equipment
- › Attach the hoist to the dedicated lifting point only, making sure it is attached in a way that does not expose the user to danger by the hoist, chain or load
- › Do not allow the load to swing
- › Do not use the davit if the kingpin shaft is not seated correctly in the socket
- › Do not use the davit if it does not rotate freely in the bearing or the bottom flange is fouled in any way, preventing free rotation of the davit

- › To avoid side pull, lowering and lifting should only be carried out when the load chain forms a straight and vertical line between the load and lifting attachment point. (Refer to figure A)



- › Do not assemble davit in non-approved sockets
- › Set up the product in its mounting socket ensuring that it is a safe location and there is no risk of falling into the hazard or lift area
- › If a risk of falling exists, a compliant barrier or separate anchor point and PFAS should be utilised to protect the worker setting up the davit system
- › Attach the load to be lifted only to the lifting points on the head or winch-line
- › If the davit is to be used in special atmospheres contact your supplier for further advice

# ➤ Correct Operation

## Disclaimer

- REID lifting sockets & extensions have been designed, developed and tested for safe use with REID equipment and form a key part of the integrity of the total system
- All sockets have a maximum moment based on the maximum reach setting of the Davit, and the socket installation and verification tests performed
- If non-standard, third-party sockets are used, REID Lifting's Declaration of Conformity & Incorporation and warranty for the products is no longer valid and the system becomes the responsibility of the client

## Warning

- The equipment should not be used outside of its limitations, or for any purpose other than that for which it is intended
- Do not lift or transport loads while personnel are in the danger zone
- Do not allow personnel to pass under a suspended load
- Never leave a suspended load unattended
- Be aware of hazards when setting up/folding down, such as trapping fingers in rotating parts
- Be aware of any adverse weather conditions such as strong or gusty winds which could impose additional horizontal loads and affect the stability of the structure. Stop using if weather is impacting on lifting, and either disassemble the system or tie it to a rigid structure to ensure it can't overturn
- Don't allow the load to hit the system

## Fall Protection

**Fall arrest: This section must NOT be read in isolation from all other sections of this manual. Read the whole manual before using this product.**

This davit product has been designed and tested to provide an anchor point as part of a personal fall protection system (PFAS). It is in conformity with BS:EN795:2012. It is suitable for use by one person for fall arrest applications attached via a self retracting lifeline (SRL), with or without recovery features. The SRL is attached to either the column and deviated through the pulley mechanisms or directly to the shackle at the head of the davit. In addition a second anchor point at the head of the column also provides a rated attachment point conforming to BS EN795:2012 for the winch operator.

When being used for fall arrest, the user must be equipped with a full body harness and a shock absorber that complies with the relevant national standards and regulations and that limits the Maximum Allowed Force (M.A.F.) To 6kN.

When lifting a fallen or stricken casualty the maximum load should not exceed the rated load (WLL) of the equipment.

Each lift must be properly planned, and all weights clearly known along with the WLLs and constraints of the personal fall protection system components and winches that make up the system. Winches used with the system should comply with EN1496:2017 or

equivalent national standard. For custom designed davits please contact your supplier for appropriate rating and capabilities.



The system is not suitable for fall arrest applications.



The system is suitable for fall arrest applications. Specify number of users. Max weight of 150kg.

## Additional Notes for Correct Operation & Warnings

- › Always carry out pre-use checks before using this equipment. It is advised to use a buddy system and inspection must be by a competent person
- › Never walk away from the footprint of the product or move outside designated safe zones whilst connected to it where there is a risk of a fall
- › When using this product as a fall arrest anchor ensure there is adequate fall clearance when working at height. A competent person should calculate this taking in to account all of the components of the personal fall arrest system.
- › Always consider the potential effects of sharp edges, chemical reagents, electrical conductivity, cutting, abrasion, climatic exposure on all components of the fall protection system, and the effect of offset forces as a result of pendulum falls
- › If the product has been subjected to a fall arrest or impact force it must be immediately removed from service
- › The substrate of the structure on which the product is placed must be able to sustain the loads specified for the device in all orientations permitted, including a safety factor of at least 2
- › Never exceed the number of allowable users
- › Never adjust the product whilst a person is attached to it
- › Only use designated anchor points for the attachment of fall protection devices
- › Ensure that any fall protection system components being used are compatible and meet the requirements of applicable standards
- › When using this product ensure that there is a rescue plan prior to starting work and ensure that users are trained in the correct execution of the plan and have all necessary rescue equipment to hand
- › Where required by regulation, each installation must be approved by a qualified person
- › Always wear appropriate PPE when installing, setting up, dismantling and using this equipment
- › Misuse of this product could result in serious injury or death

# ➤ Inspection & Maintenance

The following information is based on REID Lifting's recommendations and does not remove the responsibility of the user to comply with the relevant regulations and standards that are valid in the respective countries and regions where the system is being used.

Before each use inspect the assembly and all loadbearing components for visual defects as per the below list;

- Ensure kingpin, beam and column are free from dents or indentations
- Ensure Kingpin, Beam and column are not showing any signs of deformation
- Ensure that there is no elongation of the beam holes and that the inserts have not become loose
- Ensure that the beam clevis pins are straight and free from damage
- Ensure that the sheaves rotate freely and that there is no visible damage
- Ensure no bolts are loose
- Check brackets or attachments for signs of damage
- Test the free rotation of the kingpin and ensure that it is fully engaged in the socket. To check whether the kingpin is fully engaged, ensure that the lower bearing at the bottom of the column is flush with the top of the socket

Inspections are instigated by the user or competent person. The above list covers the main components on this product. Any accessories and third party components must be inspected following the manufacturers guidelines or corresponding instructions for use.

## Regular Inspections

To ensure that the product's remains in a safe working order it must be inspected regularly by a competent person. We recommend inspections every 6 months for personnel lifting and every 12 months for goods only, unless adverse working conditions or profile of use dictate shorter periods. The components of the system frame need to be checked for damage, wear, corrosion or other irregularities. It may be necessary to disassemble the system frame in order to do this. Particular attention should be paid to checking the profiles for denting, making sure there is no wear or elongation of the bolt holes and ensuring that the jib section is straight and true.

Any necessary repairs should only be carried out by an approved specialist workshop using original spare parts. It is recommended that once inspected or repaired, the device is marked with the date of the next inspection.



Inspections are instigated by the user. If detailed information is required on inspection and test criteria, please refer to your supplier's technical department. The equipment Inspection Record is on page 28.

If using the system in explosive atmospheres, see additional section titled ATEX.

## Maintenance & Repair

In order to ensure correct operation, the conditions for inspection and maintenance must be complied with. If any defects are found, stop using the product immediately.

No alterations or additions to the equipment should be made without the written consent of the manufacturer. Any repair must be carried out in accordance with the manufacturer's procedures.

It is recommended to maintain the equipment in a clean and dry manner. Cleaning is suggested using a sponge or cloth with warm, soapy water, rinsing and allowing to dry.

This product must be assembled using metric fixings of the same type and quality as those supplied by the original manufacturer only. Failure to do so could have an impact on the structural performance and stability of the product.

## Storage & Transportation

When transporting the components, take note of all the manual handling considerations.

Do not throw the product down or stack any items on top of it.

Always place carefully and securely on the ground to avoid damaging the equipment.

# › Sockets, Installation & Verification

## Sockets

REID's davits need to be anchored to a suitable structural surface/foundation capable of withstanding the applicable loading or used in conjunction with one of Reid's portable anchorage systems. Where fixing to a structure we strongly recommend that a structural engineer validates this prior to installation of the product.

This product can be supplied with one of the sockets specified below (only sockets supplied by REID Lifting are approved to be used with this product. More details available on page 12-14):

- › The Top Mount socket is for use on flat horizontal surfaces. It can be installed onto concrete using resin bonded anchors or into steel work using bolts
- › The Side Mount socket can be installed using resin bonded anchors or mechanical anchors
- › The Bridge Mount socket is for mounting into steel work and walkways
- › The Cast & Resin Bonded sockets can be cast into new concrete or resin bonded into existing concrete
- › **PORTX** Saddle Mount Socket for shoring and trenching applications
- › Pedestal Sockets are designed to provide additional lift height or reach over obstacles, protective rails or walls.
- › **PORTABASE** H Base, Trailer Hitch Mount and Counterbalance Systems for mobile applications

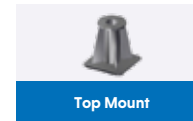

Top Mount



Side Mount



Bridge Mount

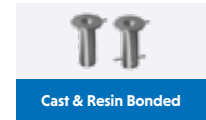

Cast & Resin Bonded



**PORTX** Saddle Mount



Pedestal Socket



**PORTABASE**® H Base



**PORTABASE**®  
Counterbalance



**PORTABASE**®  
Trailer Hitch

## Socket Installation

Socket installation should only be carried out by a qualified person, with the ability to specify the anchors, resin, and fasteners necessary to ensure an installation that is safe for use. If in any doubt about the calculation of loads, contact your REID Lifting representative.

Depending upon the socket type, there are a number of different installation options. If bolts are being used for this, then these should be minimum grade 8.8 BZP or if stainless, grade A4 or equivalent.

When installing the socket, it is important to ensure that the top face is as level as possible, with misalignment no more than 3 degrees from the horizontal.

Note: Site specific information regarding the installation of REID davit sockets CANNOT be detailed within this operating manual as each site/structure is different. A qualified engineer MUST design and approve each installation based on the minimum mounting requirements, site information and experience. Further information is cited in our technical data sheets for the chosen socket.

## Minimum Mounting Requirements

The mounting structure must be capable of withstanding design loads of 12kN.m.

For more detailed requirements please contact REID Lifting.

## REID Test Davit

REID now offers a test davit, designed for testing the strength of your socket up to 9.6kN.m. Designed to be used with a Staht device or PORTA<sup>G</sup>ANTHRY<sup>®</sup> RAPID<sup>E</sup>. Find out more at reidlifting.com.



TESTDAVIT		
Product Code	Description	Max Load [kN.m]
RTD000001	REID Test Davit	9.6

## Verifying the Installation

We recommend that the socket installation is tested before initial use, particularly when using resin bonded anchors. When verifying the installation, testing should be to no more than 125% of the associated davits capacity at its maximum reach. All tests should be carried out in all anticipated worst-case loading directions, sustained for a duration of 3 minutes.

If the socket installation can't be tested, each anchor should be isolated and tested individually applying the applicable tension and shear loading. Please contact REID for more details and for information on specially designed test apparatus.

Following initial socket installation and verification tests, we recommend periodic visual examination rather than overload tests for the socket or davit. If, as a result of the visual examination, a load test is judged to be required, then we recommend a 100% load test and certainly no more than 125%.

# ➤ Fall Protection Applications

## Compatible Davit and Fall Protection Force Ratings

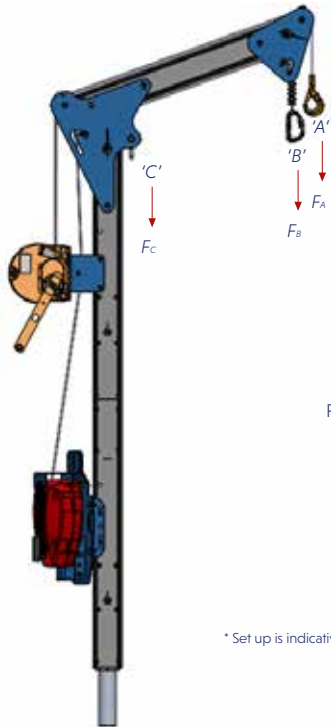

F = Maximum Rated Force

\* Set up is indicative

PFAS INFORMATION	PORTX <sup>®</sup> DAVIT			
	Davit Radius	Anchor Point 'A'	Anchor Point 'B'	Anchor Point 'C'
<b>H Base</b>	<b>800 mm</b>	12 kN	12 kN	22.2 kN
<b>Counterbalance</b>	<b>800 mm</b>	12 kN	12 kN	22.2 kN
<b>Trailer Hitch</b>	<b>800 mm</b>	12 kN	12 kN	22.2 kN
<b>PORTX<sup>®</sup> Saddle Mount</b>	<b>800 mm</b>	12 kN	12 kN	22.2 kN
<b>Fixed Sockets</b>	<b>800 mm</b>	12 kN	12 kN	22.2 kN

**ATEX**

This product has been designed for use in explosive atmospheres in line with the following requirements and information. Any use which differs or exceeds this is considered incorrect and REID Lifting Ltd will not accept any responsibility or liability for damages resulting from false application. The risk is solely with the user. If the product has been customized in any way, then it may not comply with standards and no longer be suitable for use in explosive atmospheres. If this is the case, then the product will not have any of the markings below. If in doubt, please contact your REID representative.

**ExVeritas Certification**

- > ATEX - ExVeritas 23ATEX1623X
- > UKEX - ExVeritas 23UKEX1624X

**Classification [Zone 2]**

As standard, the product meets the requirements of Category 3 equipment for use in Zone 2 explosive atmospheres, providing a normal level of protection where mixtures of air and gases, vapours or mists or by air and dusts mixtures are unlikely to occur or, if they do occur, are likely to do so only infrequently and for a short period only.

The product will have the following identification on the serial label:

**As Standard for Zone 2 Environments:**

Ⓜ II 3 GD  
 Ex h IIC T6 Gc  
 Ex h IIIC T85°C Dc  
 Tamb -20°C to +55°C

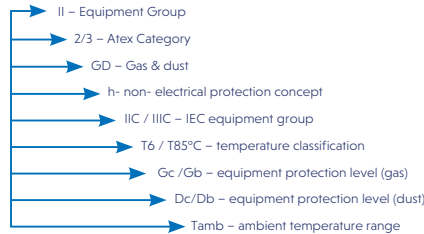

**Classification [Zone 1]**

Available as an upgrade, the product can be supplied to meet the requirements of Category 2 equipment for use in Zone 1 explosive atmospheres, providing a high level of protection where mixtures of air and gases, vapours, mists or by air and dusts mixtures are likely to occur.

The product will have the following identification on the serial label:

**As an upgrade for use in Zone 1 environments:**

Ⓜ II 2 GD  
 Ex h IIC T6 Gb  
 Ex h IIIC T85°C Db  
 Tamb -20°C to +55°C

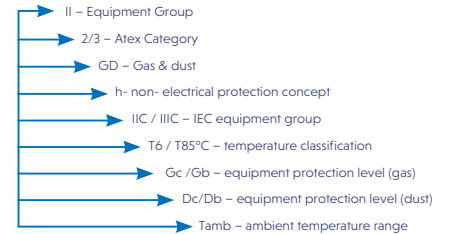

## Spark Formation

There is an increased danger of ignition when certain material pairings clash, namely non-corrosion-resistant steel or cast iron against aluminium, magnesium or pertinent alloys. This applies especially in the case of rust or surface rust. When assembling the product and inserting fastening components, these must therefore be clear of rust and debris of any kind. As stated previously, care must be taken to ensure the product is handled in a suitable manner, never thrown down and always placed carefully onto the ground.

REID recommends the use of corrosion resistant tools when assembling this product to prevent the possibility of any sparks.

## Static Electricity

For Zone 1 and 2 applications, there is a potential risk of static electricity build-up leading to an incentive spark. Although the risk of such ignition is unlikely, the system must be earthed during assembly and use. The sockets should be in direct contact with the ground and there should be no membrane separating the socket from the ground. If the route to earth for the structure cannot be guaranteed, then an earthing cable should be used.

## Inspection, Maintenance & Repair

Special attention should be given to dust deposits on the structure, especially in areas where the profiles come into contact, and should be wiped clean and care taken not to apply materials that could create electrostatic charging.

Additionally, the kingpin should be checked to ensure it rotates freely and the lower bearing must be ensured to be fixed to the structure with no possibility of a build-up of debris between the contact surfaces.

The structure is predominantly constructed from aluminum which will not rust. However, there are steel components used throughout. These are the fasteners, shackles and sockets. Where there is sign of any rust deposits on the aluminium structure, it should be wiped clean as above and, where there is sign of rust on a steel component, that component should be removed from use and the structure not used until a replacement is fitted.

If using the product in explosive atmospheres, in addition to the Regular Inspection and Maintenance information above, these additional instructions should be followed:

- ▶ Inspections must be instigated by the user prior to each use if used in a potentially explosive atmosphere.
- ▶ Inspections and maintenance must be carried out at a safe distance away from an explosive atmosphere.



# ► Assembly Instructions - Double Winch

The **PORTX** DAVIT and its constituent components are described in the image below.

The socket type may vary between a Top Mount, Side Mount, Bridge Mount, Cast In, Resin Bonded or one of the portable sockets referenced in this manual, depending on the application of use.

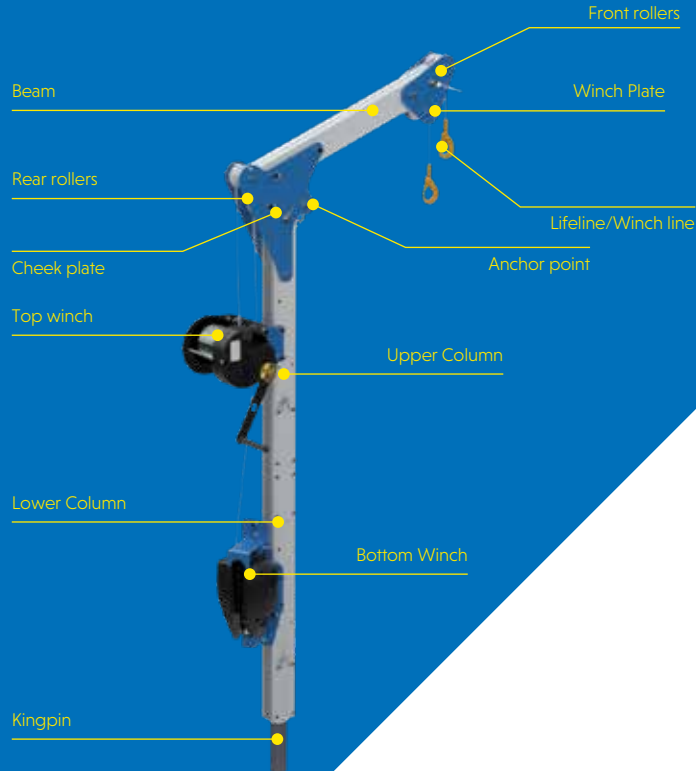

Appropriate PPE should be worn: ► Gloves ► Protective Footwear ► Hard Hat



**Assembling the PORTX® DAVIT with a double winch on a PORTABASE® Counterbalance**

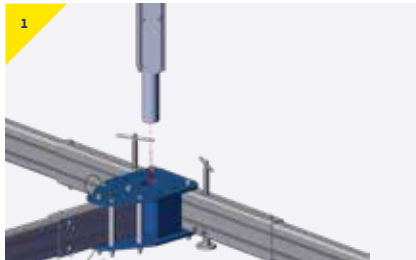

➤ Insert the lower section into the socket.

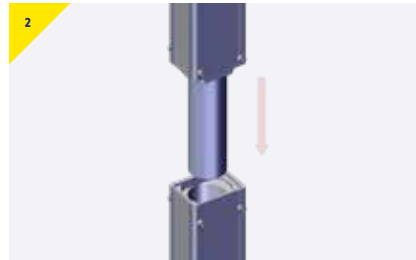

➤ Insert the upper section into the lower section and ensure it's fully engaged.

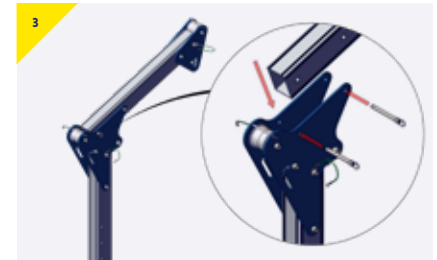

➤ Position the beam inside of the cheek plates, line up the holes and secure using the two detent pins.

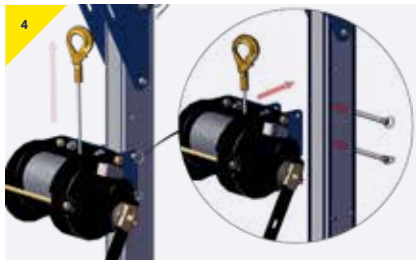

➤ Attach the desired winch and bracketry to the upper column, refer to instructions for individual brackets and devices for assembly and operation information.

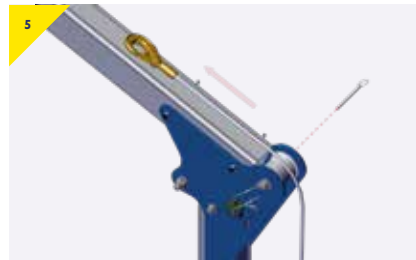

➤ Feed the hook over the roller at the rear of the cheek plate, secure the cable on the roller using the detent pin.

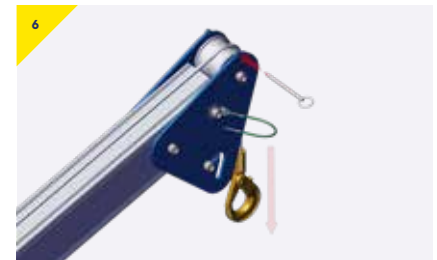

➤ Pull the hook over the front roller of the beam and secure using the detent pin.

# ➤ Assembly Instructions

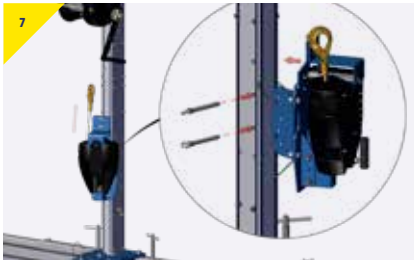

- Attach the desired SRL and bracketry to the lower column, refer to instructions for individual brackets and devices for assembly and operation information.

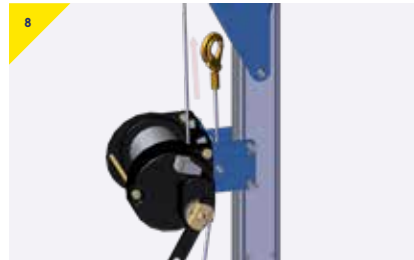

- Feed the hook through the roller located between the winch bracket fins, secure the cable between the roller and the column using the detent pin.

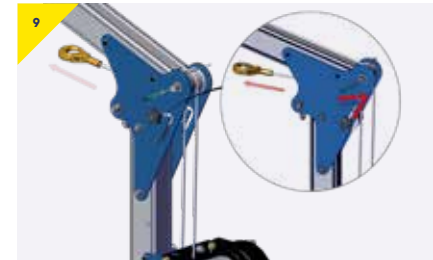

- Ensure roller is in lower slot position, feed the hook through the cheek plates over the roller between column and beam. Slide roller into upper slot position to ensure cable is retained by beam.



- Ensure roller is in lowest slot position, feed cable over lower front roller. Slide roller into upper slot position, ensuring cable runs freely over roller and is retained by beam.

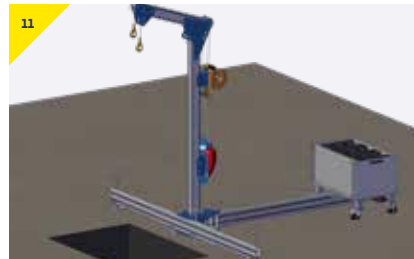

- The PortX davit is now ready to be used as fall protection/man riding when entering and exiting a confined space.

**The example shown utilises a PORTABASE® Counterbalance, however the set up is universal across the whole range of REID's PORTABASE® systems.**



# ► Assembly Instructions - Single Winch

The **PORTX** DAVIT and its constituent components are described in the image below.

The socket type may vary between a Top Mount, Side Mount, Bridge Mount, Cast In, Resin Bonded or one of the portable sockets referenced in this manual, depending on the application of use.

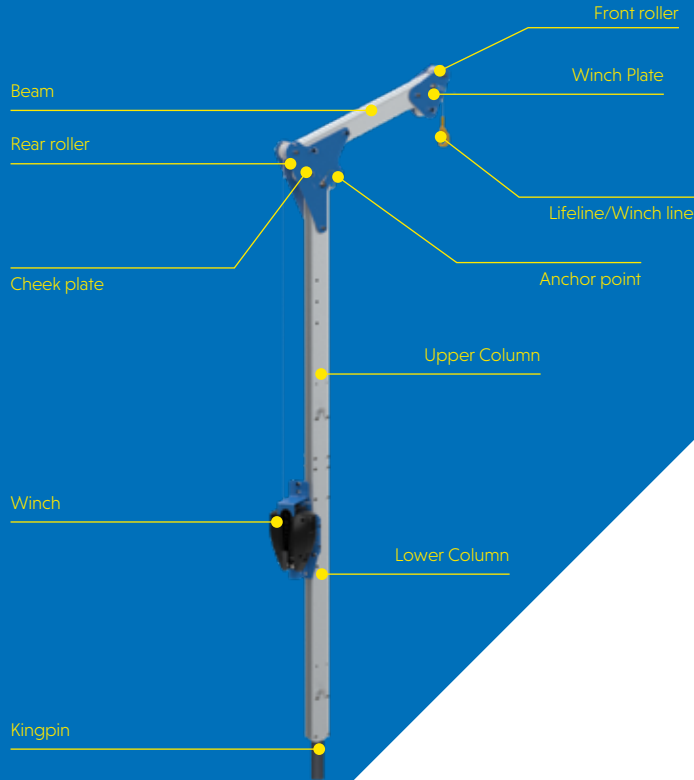

Assembling the PORTX® DAVIT with a single winch on a PORTX® Saddle Mount Socket



- 1 Place the PortX Saddle Mount Socket over the joint on a trench sheet or trench box. Ensure that the unit sits flush with the top each and is level.

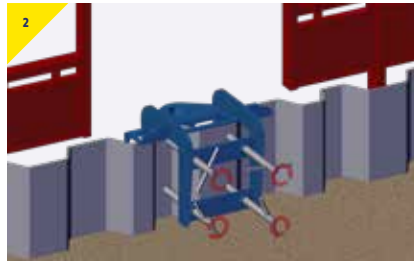

- 2 Tighten each of the 4 handles, ensuring that each have engaged with the trenching sheet/box, please note each handle will need to be checked several times as the structure settles between tightening operations.

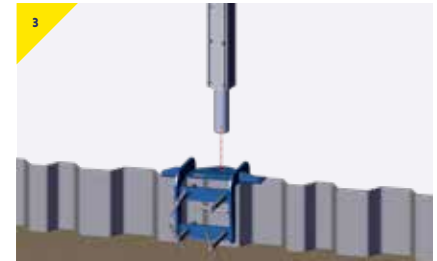

- 3 Insert the lower section into the socket.

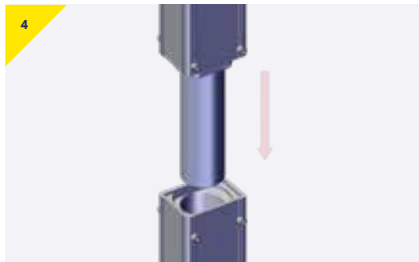

- 4 Insert the upper section into the lower section and ensure it's fully engaged.

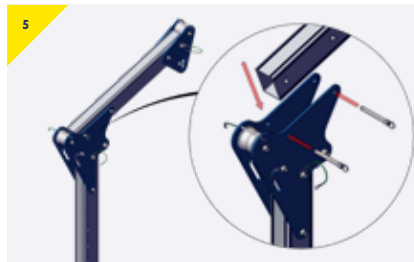

- 5 Position the beam inside of the cheek plates, line up the holes and secure using the two detent pins.

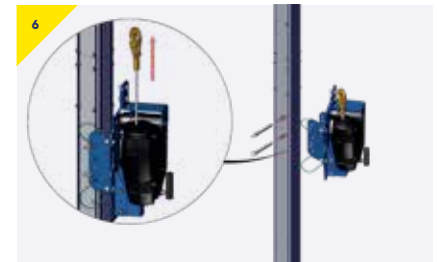

- 6 Attach the desired SRL device and bracketry to the column, refer to instructions for individual brackets and devices for assembly and operation information.

# ➤ Assembly Instructions

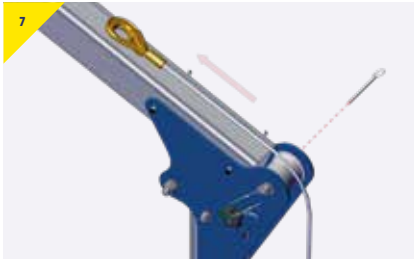

- Feed the hook over the roller at the rear of the cheek plate, secure the cable on the roller using the detent pin.

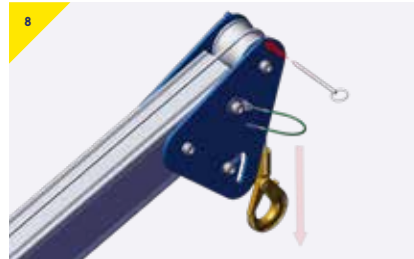

- Pull the hook over the front roller of the beam and secure using the detent pin.



- The PortX davit is now ready to be used as fall protection when entering and exiting the trench.

## PORTX<sup>®</sup> DAVIT

- A** Radius
- B** Overall height of lift
- C** Height to top of beam

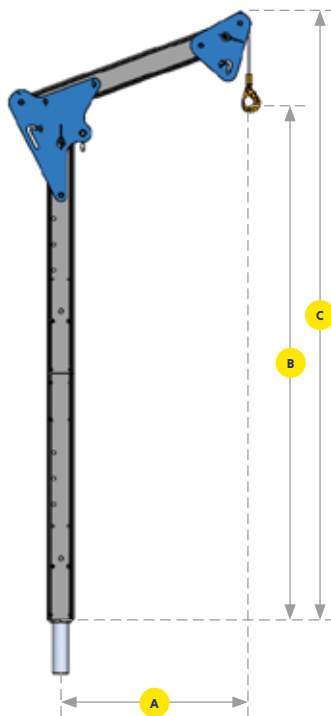

Model	Max User Weight [kg]	Max goods weight [kg]	Dimensions [mm]		
			A	B	C
PTXDR800-20	150	300	800	2000	2371
PTXDR800-24	150	300	800	2400	2771
PTXDR800-28	150	300	800	2800	3171

# ➤ Quality & Safety

## Regulations, Standards & Directives

This product complies with the following:

- BS EN795:2012 [UK, EU & ROW]
- PDCEN/TS16415:2013 [UK, EU & ROW]
- OSHA 1926 sub part M [US]
- ANSI Z359.18 2017 [US]
- ATEX Directive - 2014/34/EU
- Machinery Directive 2006/42/EC
- PPE Regulation (EU) 2016/425
- The Provision and Use of Work Equipment Regulations 1998 (S.I. 1998 No. 2306)
- The Lifting Operations and Lifting Equipment Regulations 1998 (S.I. 1998 No. 2307)

It is essential to adhere to the safety regulations of the respective country for using manual lifting equipment.

## Accreditations

Quality and safety are key themes throughout this document and the REID Lifting ethos. It is with this in mind that we have undertaken external accreditations to ensure we stay focused on what is important to our clients and users, and ahead of market trends and developments.

REID Lifting is continuously audited by Lloyds Register Quality Assurance (LRQA) for approval of its Integrated Management System combining quality systems management, environmental issues and the health and safety practices within the company.

- ISO 9001:2015 - Specifies requirements for a quality management system for any organization that needs to demonstrate its ability to consistently provide products that meet customer and applicable regulatory requirements and aims to enhance customer satisfaction
- ISO 14001:2015 - Specifies the requirements for implementing environmental management systems throughout all areas of the company
- ISO 45001 – Health & Safety Management System

- LEEA Membership - REID Lifting is a full member of the Lifting Equipment Engineers Association (LEEA membership 000897). REID Lifting conforms to the main aims of the association which is to achieve the highest standards of quality and integrity in the operations of members. Entry qualifications are demanding and strictly enforced through technical audits based on the Technical Requirements for Members



## Conformité Européenne [CE] & UK Conformity Assessed [UKCA]

REID Lifting's products have been designed, tested and approved (as appropriate) by the Conformité Européenne and UK Conformity Assessed. This certifies that REID Lifting's products meet the demands of the European and UK Directives and Regulations regarding Health and Safety requirements. The EC type-examination for this device has been carried out by SGS United Kingdom Ltd, 202b, Worle Parkway, Weston-super-Mare, BS22 6WA, United Kingdom (CE body no.0120) in accordance with Module B of the PPE Regulation. The EC quality assurance system for this device has been carried out by SGS Fimko Oy, Takomotie 8, FI-00380 Helsinki, Finland. (CE body no. 0598) and SGS United Kingdom Ltd, 202b, Worle Parkway, Weston-super-Mare, BS22 6WA, United Kingdom (CE body no.0120) in accordance with Module D PPE Regulation (EU) 2016/425 and as brought into UK law and amended.

## Testing

Testing and technical file review are integral parts of our design and manufacturing process. External verification of products is undertaken where appropriate, using government approved Notified Bodies.

All products have been thoroughly type tested. Each product is supplied with a certificate of conformance and individual record of thorough examination or test.

## Language

It is essential for the safety of the user that if this product is re-sold outside of the original country of destination, the reseller shall provide instructions for use, maintenance, inspection and repair in the language of the country where it will be used.

## Product IPR

Intellectual property rights apply to all REID Lifting Ltd products. There are patents in place, or pending, for:

**PORTAGANTRY**® | **PORTAGANTRY** RAPIDE | **PORTADAVIT** QUANTUM | **TDAVIT**™

All product names are trademarks of REID Lifting Ltd:

**PORTAGANTRY**® | **PORTAGANTRY** RAPIDE | **PORTADAVIT**™ | **PORTABASE** | **TDAVIT**™ | **PORTAQUAD**™ | **PORTX**™

# Product Labelling Key

## Safety Labels



Insert and secure the bolt before loading the system.



Insert the detent pin and fully engage before loading the system.



Insert the clevis pin and secure with the clip before loading the system.



Restraint point only.



Read the operational manuals before using the system.



Ensure the pin is fully engaged.

## Serial Labels

1. Product Number
2. Serial Number
3. WLL
4. Year of Manufacture
5. Standards
6. ATEX
7. Max Moment



The system is not suitable for fall arrest applications.

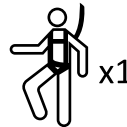

The system is suitable for fall arrest applications. Specify number of users. Max weight of 150kg.

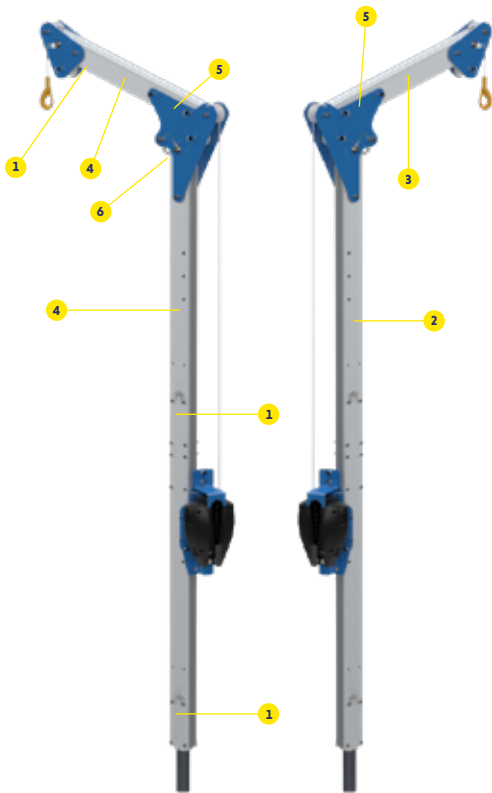

## Product labelling

The following labels must be present on your system and must be legible.

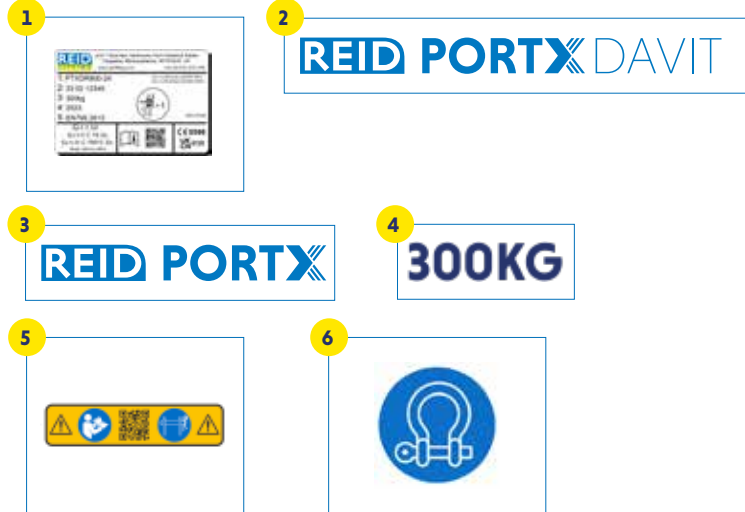

# ➤ Product Identification & Inspection Record

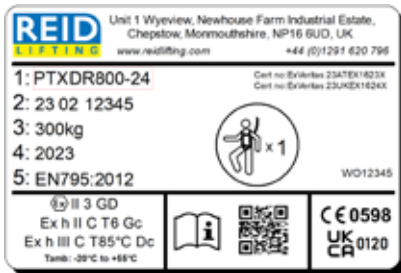

## Marking

The serial labels indicate:

- The product identification number
- The product's unique serial number
- The goods' capacity (WLL) of the device
- The year of manufacture
- The standards to which the device is approved
- The ATEX rating of the product (if applicable)
- CE Marking
- Minimum braking load (MBL)

Insert data from serial numbers found on product into table here:

---

---

---

---

---

---

---

---

### Periodic Examination & Repair History

Date	Inspected by	Pass/Fail	Corrective Action	Comments



---

---

---

---

---

---

---

---

---

---

---

---

---

---

---

---

---

---

---

---

---

---

---

---

---

---

---

---

---

---

---

# Contact Us

## Head Office, UK

Unit 1 Wyeview  
Newhouse Farm Industrial Estate  
Chepstow  
Monmouthshire  
NP16 6UD  
United Kingdom

-  +44 (0)1291 620 796
-  [enquiries@reidlifting.com](mailto:enquiries@reidlifting.com)
-  [www.reidlifting.com](http://www.reidlifting.com)

All information herein is copyright protected by REID Lifting Ltd. All company and product names are Trade Mark and Trade Name protected and all REID Lifting Ltd. Product IPR is protected under Patents, Patents Pending and/or Design Rights.



Printed using environment friendly processes and materials.