



PORTAGANTRY®

Load Bearing Pneumatic Castor Model

➤ Assembly & Operation Guide

Contents

Correct Operation	4	Assembly Instructions	10
Intended Use		Beam Height Adjustment	14
Inspection Prior to Initial Operation		Variants & Options	15
Inspection Before Starting Work		Dimensions	16
Maximum Capacity		Quality & Safety	18
Temperature Range		Regulations	
Notes for Correct Operation		Accreditations	
Warning		Conformité Européenne [CE] & UK Conformity	
Traversing the Load		Assessed [UKCA]	
Moving under Load		Testing	
Additional Notes for Correct Operation		Language	
Warning		Product IPR	
Inspection & Maintenance	7	Product Labelling	20
Regular Inspections		Inspection Record	22
Maintenance & Repair			
Storage & Transportation			
ATEX	8		
ATEX			
Classification [Zone 2]			
Spark Formation			
Static Electricity			
Inspection, Maintenance & Repair			

Lightweight. Portable. **Safe.**

Please read the following instructions and guidance notes carefully, before using or operating the system.

They contain important information about how to handle and use the system in a safe and efficient way, avoiding danger, reducing repair costs and downtime, and increasing the reliability and lifespan of the system.

They apply for:

- Operation, including preparation, troubleshooting during operation and cleaning
- Maintenance, inspection, repair
- Transportation

It is the responsibility of the end user to adhere to the Health & Safety and accident prevention standards and legislation valid in their respective countries and any regions in which the system is being used. It is also incumbent on the user or competent person to ensure that anyone working with the equipment has the necessary medical and physical capabilities. A rescue plan also needs to be in place in the event of an emergency that could occur during the work. This document should form part of the overriding Risk Assessment and Method Statement required for each lift.

➤ Correct Operation

Intended Use

This product is intended to be used for the lifting of goods.

It is expected that all users of this product have the necessary medical and physical capabilities, are fully trained and competent in its safe assembly and use.

Inspection Prior to Initial Operation

This product must be inspected prior to initial operation by a competent person to ensure that the structure is safe and that it has not been damaged by incorrect assembly, transport or storage.

Inspection Before Starting Work

Before starting work, the assembly of the product and all load-bearing components should be checked for visual defects. This includes checking the integrity of all profiles for denting, making sure there is no wear or elongation on the bolt holes and ensuring that the trolley moves freely along the beam.

Maximum Capacity

Goods Lifting: This product is designed to lift and lower loads up to its rated capacity. Do not exceed the working load limit indicated on the product.

Temperature Range

This product can be operated in ambient dry temperatures between -20°C and $+50^{\circ}\text{C}$ (-4°F and 122°F). Consult your supplier in case of extreme working conditions.

Notes for Correct Operation

- Assemble only as instructed (ensure all bolts are present and fitted correctly as per instructions)
- Suitable, appropriately rated winches and connection plates must be used for all applications
- The product should be set up at a safe distance from the lift area, before moving the structure into place
- The supporting ground/structure where the gantry is to be used must be stable and capable of withstanding the maximum expected load applied during use
- We recommend that gloves are worn when using the equipment
- The beam must be horizontal prior to any lift and A-Frames vertical and parallel to each other
- Do not use the product if the trolley does not run freely along the beam. (For certain applications, the trolleys can be locked into position)
- Attach the hoist to the lifting point on the trolley only, making sure it is attached in a way that does not expose the user to danger by the hoist, chain or load
- Only raise and lower loads when castor brakes are engaged

- Do not allow the load to swing
- To avoid side pull, lowering and lifting should only be carried out when the load chain forms a straight and vertical line between the load and lifting attachment point on the trolley (refer to figure A)

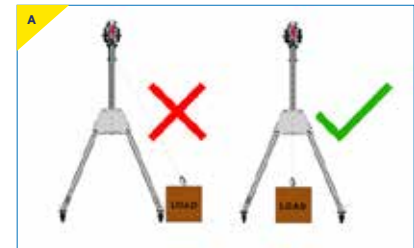

- We recommend the use of load-sensing or overload protection devices on all lifts
- The risk assessment and method statement must take into account any factors that might apply additional loading to the system during lifting operations
- Take care when transporting and storing the system to avoid damage
- To ensure stability of the structure, the operating span of the beam must be equal to or greater than the distance between the castors on the A-Frame

Warning

- › The equipment should not be used outside of its limitations, or for any purpose other than that for which it is intended
- › Do not lift or transport loads while personnel are in the danger zone
- › Do not allow personnel to pass under a suspended load
- › Never leave a suspended load unattended
- › Do not start moving the load along the beam until you have checked that it has been attached correctly
- › Don't allow the load to hit the system frame
- › When winching, only use one winch with each sheave and make sure they never cross paths with each other
- › Be aware of any adverse weather conditions such as strong or gusty winds which could impose additional horizontal loads and affect the stability of the structure. Stop using if weather is impacting on lifting, and either disassemble the gantry or tie it to a rigid structure to ensure it can't overturn
- › Be aware of hazards when setting up/folding down, such as trapping fingers in rotating parts

Traversing the Load

Due to a high modulus of elasticity in aluminium, when loaded the gantry beams will deflect. This is perfectly normal for our products. Using aluminium enables us to achieve the highest levels of strength to weight ratio, which is an important feature of portable gantries. The level of deflection will be determined by the span length and the beam profile that is being used, as well as the weight of the load being lifted.

Before traversing loads on the **PORTAGANTRY**, it is important to take in to account the following;

- › Only use appropriate REID trolleys to move the load on the beam
- › When moving a loaded trolley along the beam, move the load steadily and in a controlled manner. Do not apply an excessive force to try and move the load if it does not move easily
- › Depending upon the beam section (A, B or D), beams will deflect when loaded. **This is normal.** The greater the load, the greater the deflection. Please refer to our beam deflection table for more information. Deflection must be taken into consideration when planning the lift
- › Any traversing of loads along the beam must be performed in a controlled manner to ensure complete stability of the structure throughout the operation

- › Deflection of the **PORTAGANTRY** can be reduced (or limited) by increasing or down rating its working load limit (WLL) by 50%. Increasing the beam section can also help limit deflection. Please contact REID for further advice
- › Another safe recommendation for moving the load along the beam is to use a mechanical aid. REID Lifting can supply you with our geared trolleys or rope control systems. The rope control system is particularly useful on longer beams or where the gantry is at maximum height of lift
- › Using a mechanical aid such as a geared trolley, chain hoist in conjunction with shackled cheek plates or rope control system for traversing the load helps optimise the gantry capacity

The Trolley Rope Control system has the added advantage of enabling the operator to control the movement of the trolley from a safe location at the side of the gantry. The system includes a winch and series of sheaves that produce a mechanical advantage and reduce the effort during operation.

➤ Correct Operation

For guidance we recommend the maximum loads that can be safely moved with standard trolleys without a mechanical aid (subject to all other site conditions being taken into consideration in a risk/hazard analysis) are:

- A section beams up to 4570mm = <500kg or 50% capacity of the gantry whichever is lower
- B section beams up to 5500mm = <500kg or 50% capacity of the gantry whichever is lower
- D section beams up to 5500mm = <1000kg or 50% capacity of the gantry whichever is lower
- D section beams up to 8400mm = <500kg or 50% capacity of gantry whichever is lower

To be able to effectively and safely move loads above these limits the operator should use the most appropriate mechanical aid. For further advice, please contact REID Lifting or a qualified or competent person.

Incorrect use of the gantry could lead to accidents causing personal injury and/ or damage to equipment and infrastructure. Please ensure that the advice and guidelines in this Assembly & Operation Guide are followed.



Moving under Load

When moving the gantry underload, the following instructions **MUST** be followed:

- This product can only be moved in the direction perpendicular to the beam
- Directional locks must be used on the castors (perpendicular to the beam only)
- The end user **MUST** make sure the center of gravity of the load is known and the lifting points are in such a way that the load is **EQUALLY** distributed, so the load generates a vertical pull to the beam



- The load is not allowed to swing
- The floor must be flat, free from substantial cracks, steps or changes in levels and the weather conditions should be safe for the operation (i.e. not when frost, ice or snow present)
- A risk assessment and method statement are required to be completed by a competent person before moving the gantry under load
- The gantry's movement must be controlled at a slow speed, no sudden movements or high speeds are allowed

		Standard Beam Length [mm]								
WLL [kg]		3000	3920	4570	5500	6000	8400			
2000	A	25-30mm	A	35-45mm	A	50-60mm	B	65-75mm	D	80-90mm
	B	30-35mm	B	45-55mm	B	70-80mm	D	40-50mm	D	50-60mm
3000	B	30-35mm	B	45-55mm	B	70-80mm	D	40-50mm	D	50-60mm
	D	30-35mm	D	45-55mm	D	70-80mm	D	40-50mm	D	50-60mm

Approx Beam Deflection at Max Capacity [mm]

➤ Inspection & Maintenance

The following information is based on REID Lifting's recommendations and does not remove the responsibility of the user to comply with the relevant regulations and standards that are valid in the respective countries and regions where the system is being used.

Regular Inspections

To ensure that the product's frame remains in safe working order it must be inspected regularly by a competent person. We recommend inspections every 6 months for personnel lifting and every 12 months for goods only, unless adverse working conditions or profile of use dictate shorter periods. The components of the system frame need to be checked for damage, wear, corrosion or other irregularities. It may be necessary to disassemble the system frame in order to do this. Particular attention should be paid to checking the profiles for denting, making sure there is no wear or elongation on the bolt holes and ensuring that the trolley moves freely along the beam.

Any necessary repairs should only be carried out by an approved specialist workshop using original spare parts. It is recommended that once inspected or repaired, the device is marked with the date of the next inspection.

Inspections are instigated by the user. If detailed information is required on inspection and test criteria, please refer to your supplier's technical department. The equipment Inspection Record is on page 23.

If using the product in explosive atmospheres, see additional section titled ATEX.

Maintenance & Repair

In order to ensure correct operation, the conditions for inspection and maintenance must be complied with. If any defects are found, stop using the product immediately.

No alterations or additions to the equipment should be made without the written consent of the manufacturer. Any repair must be carried out in accordance with the manufacturer's procedures.

It is recommended to maintain the equipment in a clean and dry manner. Cleaning is suggested using a sponge or cloth with warm, soapy water, rinsing and allowing to dry.

Storage & Transportation

When transporting the components, take note of all the manual handling considerations.

Do not throw the product down or stack any items on top of it.

Always place carefully and securely on the ground to avoid damaging the equipment.

ATEX

This product has been designed for use in explosive atmospheres in line with the following requirements and information. Any use which differs or exceeds this is considered incorrect and REID Lifting Ltd will not accept any responsibility or liability for damages resulting from false application. The risk is solely with the user. If the product has been customised in any way, then it may not comply with standards and no longer be suitable for use in explosive atmospheres. If this is the case, then the product will not have any of the markings below. If in doubt, please contact your REID representative.

Classification [Zone 2]

As standard, the product meets the requirements of Category 3 equipment for use in Zone 2 explosive atmospheres, providing a normal level of protection where mixtures of air and gases, vapours or mists or by air and dusts mixtures are unlikely to occur or, if they do occur, are likely to do so only infrequently and for a short period only.

The product will have the following identification on the serial label:

As Standard for Zone 2 Environments:

II 3 GD

Ex h IIC T6 Gc

Ex h IIIC T85°C Dc

Tamb -20°C to +55°C

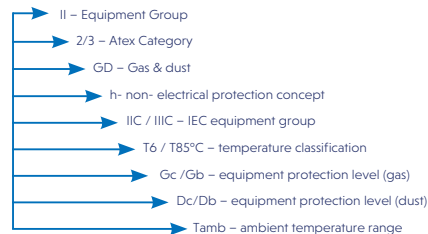

Spark Formation

There is an increased danger of ignition when certain material pairings clash, namely non-corrosion-resistant steel or cast iron against aluminium, magnesium or pertinent alloys. This applies especially in the case of rust or surface rust. When assembling the product and inserting fastening components, these must therefore be clear of rust and debris of any kind. As stated previously, care must be taken to ensure the gantry is handled in a suitable manner, never thrown down and always placed carefully onto the ground.

- > For Zone 2 applications, the height of the system should not be adjusted using the ratchet mechanism and/or geared wheel within those zones
- > REID recommends the use of corrosion resistant tools when assembling this system to prevent the possibility of any sparks

Static Electricity

For Zone 2 applications, there is a potential risk of static electricity build-up leading to an incentive spark. Although the risk of such ignition is unlikely, the system must be earthed during assembly and use. This can be achieved by attaching an earthing lead to a convenient location on metallic parts of both the system and trolley.

Inspection, Maintenance & Repair

Special attention should be given to dust deposits on the structure, especially in areas where the profiles come into contact, and should be wiped clean and care taken not to apply materials that could create electrostatic charging. Additionally, the bearings in the trolley rollers and castors should be checked to ensure they rotate freely.

The structure is predominantly constructed from aluminium which will not rust. However, there are steel components used throughout. These are; fasteners, castors, master-link, trolley rollers, A-Frame height adjustment gearing system (if fitted) and the height adjustment ratchet (if fitted).

Where there is sign of any rust deposits on the aluminum structure, it should be wiped clean as above and, where there is sign of rust on a steel component, that component should be removed from use and the structure not used until a replacement is fitted.

If using the product in explosive atmospheres, in addition to the Regular Inspection and Maintenance information above, these additional instructions should be followed:

- Inspections must be instigated by the user prior to each use if used in a potentially explosive atmosphere
- Inspections and maintenance must be carried out at a safe distance away from an explosive atmosphere

► Assembly Instructions

The PORTA GANTRY and its constituent components are described in the image below.

Appropriate PPE should be worn: ► **Gloves** ► **Protective Footwear** ► **Hard Hat**





Gantry Tool Set (supplied as an option):

- Ratchet handle 1/2" sq drive
- 24mm socket
- 24mm combination spanner
- 14mm long series allen key
- 14mm Hex key socket
- Strap Kit
- Pulling device



- Lift the A-Frame and unfold the assembly wheel leg. This will allow the A-Frame to rest between the wheel assembly leg and the pneumatic castors.



- Lay the two A-Frames a beam length apart on a flat surface in line with each other. Offer one end of the beam to the rear bolt-hole on the cheek-plate and insert a bolt, repeat on opposite A-Frame. Ensure trolley is fitted and locked onto the beam before securing the beam to the frames.



- Attach the required length straps (strap kits available from REID), and a masterlink to both sides of the A-Frame forming a 'V'.



- Attach the extension strap to the masterlink, this is to ensure the pulling device will be located inside of the beam span and not under the A-Frame.



- Position the pulling device (available to purchase from REID) between the masterlink and extension strap and connect it up, ensure the pulling device is located around the centre of the beam.

➤ Assembly Instructions



If attaching a lifting device to the gantry, ensure you attach this now and brake the trolley using the hand wheel.

- Engage the directional locks on all castors and apply the brake to one side of the gantry, castors need to be rotated to the orientation shown in images.



- Operate the pulling device and erect the first A-Frame. The assembly aid leg can be folded down once the A-Frame is lifted off the floor to maintain the working span of the beam.



- Insert the bolts into the A-Frame and tighten, securing the beam in place.



- To erect the second A-Frame, place the brake on the first A-Frame [that is in position] and ensure break on the second A-Frame is not engaged.



- Operate the pulling device again and erect the second A-Frame.



- Insert the bolts into the A-Frame and tighten, securing the beam in place.

13



- Remove all of the straps, masterlinks and pulling devices from the gantry.

14



- The shackled cheek plate has an integrated shackle pull point which allows for the attachment of a mechanical aid such as a chain hoist to control the movement of a loaded trolley along the beam.

14a

By utilising a chain hoist to connect the trolley to the shackle the effort required to move a load during a lifting operation will be significantly reduced. This enables controlled movement of a load and ensures gantry stability when traversing a load along a beam.

15



- Raise the gantry to the height required using the ratchet attachments.

16



- Before performing a lift, ensure that the castors are positioned perpendicular to the beam and that the brakes are applied.

17



- The gantry is now ready to be used.

➤ Beam Height Adjustment

Ratchet System

Two Person Operation Recommended – one on each A-Frame.

Always wear gloves when using this item.

- Release Ratchet (Figure 1). Ensure the hook at the end of ratchet strap is positively engaged within the bottom hole of the A-Frame upright (Figure 2)
- Ensure Castor brakes are engaged
- Remove lower bolt on trap plate [3.1]
- Tension ratchet strap to take the upright/beam weight [3.2]
- Remove upper bolt on trap plate [3.3]
- Operate ratchet to adjust height to required setting, ensuring that the bolt holes are aligned as in figure 5
- Re-insert upper bolt and nut/washer assembly [5.1]
- Ease tensioned strap aside [5.2], re-insert lower bolt and secure [5.3]
- Repeat steps on the second A-Frame, ensuring that the gantry uprights are vertical, and the beam is horizontal
- Check all bolts on the gantry are sufficiently secure by ensuring all spring washers are fully depressed

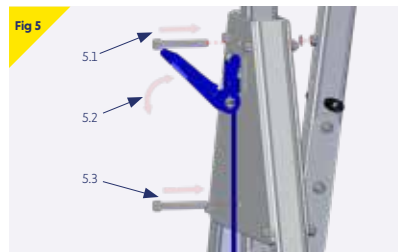
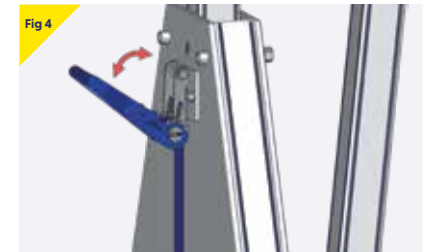
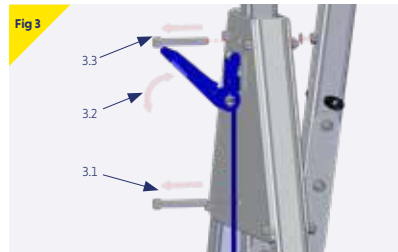
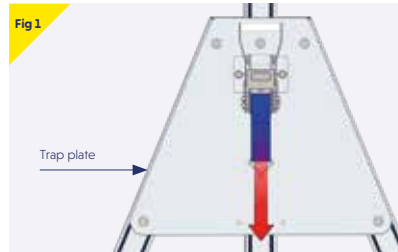

› Variants & Options

Shackled Cheek Plates

The cheek plate with shackle pull point offers a mechanical aid to move the load along the beam in a control manner.

A chain block is required for this operation with a minimum capacity of 250kg.

Notes for Correct Operation

- › Ensure the chain block is attached to the shackle on the cheek plate, and on the master link of the trolley
- › The movement of the load should be from the center of the beam to the A-Frame where the chain block is attached
- › The load chain will allow for the movement of the trolley, controlled by the operator using the hand chain on the block
- › If the load is required to be moved in both directions along the beam a second chain hoist can be added on the opposite shackled cheek plate

Customised Configurations

For customised systems additional assembly and operation information may be provided as required.

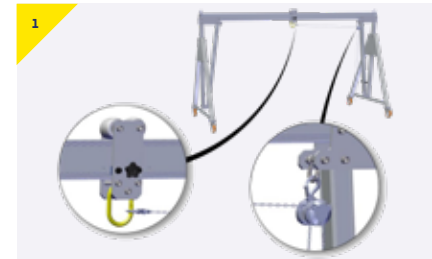

- › Connect the chain block to the shackle on the cheek plate as shown
- › Release the load chain until reaching the master link of the trolley, connecting the hook as shown



- › Operate the chain block to move the trolley along the beam

> Dimensions

PORTAGANTRY™

- A** Beam length
- B** Beam adjustment
- C** Clear operating span
- D** Height to lifting eye
- E** Height increment
- F** Height to top of beam
- G** Width
- H** Height to top of roller

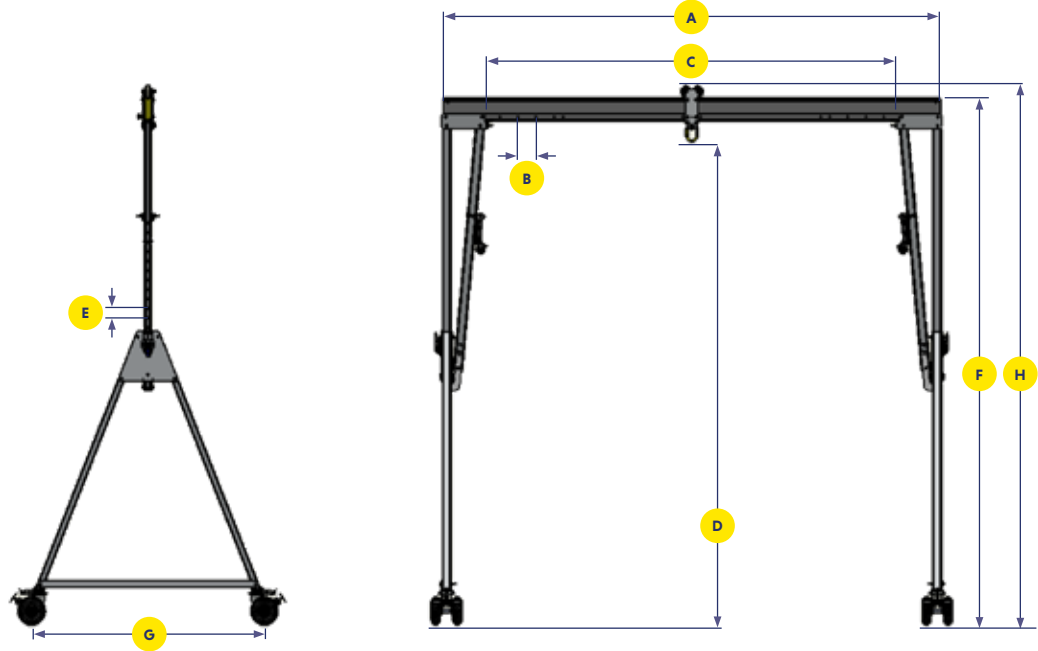

Beam Height Adjustment

The height of each gantry beam is easily adjusted by the release of 2 bolts on each upright and can be easily and safely raised into position by increments of 100mm.

Beam Options (mm)

Standard Beam Length A (mm) (Clear Operating Span C = A - 1030 mm)

		3000	3920	4570	5500	6000	8400
WLL Rating (kg)	A (mm)	3000	3920	4570	5500	6000	8400
	C min (mm)	1570	2090	1940	2870	3370	5770
	C max (mm)	1970	2890	3540	4470	4970	7370
	2000	22	29	34	52	93	130
	3000	22	37	43	85	93	130

Weight of Beams [kg]

*Clear operating span for D section beams is C = A - 1020mm.
To ensure stability of the structure, the operating span of the beam must be equal to or greater than the distance between the castors on the A-Frame.

Frame Options (mm)

Dimensions [mm]

Frame size [Product Code]	Dmax	E	Dmin	Fmax	Hmax	Hmin	G	A frame weight (KG)	Trolley roller size	Castor dimension
	Height to lifting eye	Height increment	Height to lifting eye	Height to top of the beam	Height to top of the roller	Height to top of the roller	Width			
PGAS02000I-PN	3307	10 x 100	2307	3637	3719	2719	2032	94	82	315
PGAS02000TC1-PN	5916	18 x 100	4116	6278	6360	4560	3027	146	82	315
PGAS02000TC3-PN	5113	12 x 100	3913	5476	5558	4358	2851	135	82	315
PGAS02000T-PN	4198	12 x 100	2998	4528	4610	3410	2317	100	82	315
PGAS03000I-PN	3307	12 x 100	2307	3637	3719	2719	2032	117	82	315
PGAS03000TC2-PN	5648	16 x 100	4048	5978	6060	4460	3027	141	82	315
PGAS03000TC3-PN	5113	12 x 100	3913	5476	5558	4358	2851	135	82	315
PGAS03000T-PN	4198	12 x 100	2998	4525	4607	3407	2315	129	82	315

Dimensions use standard Master Link Trolley, other options available to increase resulting height of lift (HoL) and to assist with load movement.

➤ Quality & Safety

Regulations, Standards & Directives

This product complies with the following:

- ATEX Directive - 2014/34/EU
- Machinery Directive 2006/42/EC
- PPE Regulation (EU) 2016/425
- The Provision and Use of Work Equipment Regulations 1998 (S.I. 1998 No. 2306)
- The Lifting Operations and Lifting Equipment Regulations 1998 (S.I. 1998 No. 2307)

It is essential to adhere to the safety regulations of the respective country for using manual lifting equipment.

Accreditations

Quality and safety are key themes throughout this document and the REID Lifting ethos. It is with this in mind that we have undertaken external accreditations to ensure we stay focused on what is important to our clients and users, and ahead of market trends and developments.

REID Lifting is continuously audited by Lloyds Register Quality Assurance (LRQA) for approval of its Integrated Management System combining quality systems management, environmental issues and the health and safety practices within the company.

- ISO 9001:2015 - Specifies requirements for a quality management system for any organization that needs to demonstrate its ability to consistently provide products that meet customer and applicable regulatory requirements and aims to enhance customer satisfaction
- ISO 14001:2015 - Specifies the requirements for implementing environmental management systems throughout all areas of the company
- ISO 45001 – Health & Safety Management System
- LEEA Membership - REID Lifting is a full member of the Lifting Equipment Engineers Association (LEEA membership 000897). REID Lifting conforms to the main aims of the association which is to achieve the highest standards of quality and integrity in the operations of members. Entry qualifications are demanding and strictly enforced through technical audits based on the Technical Requirements for Members

Conformité Européenne [CE] & UK Conformity Assessed [UKCA]

REID Lifting's products have been designed, tested and approved (as appropriate) by the Conformité Européenne and UK Conformity Assessed. This certifies that REID Lifting's products meet the demands of the European and UK Directives and Regulations regarding Health and Safety requirements. The EC type-examination for this device has been carried out by SGS United Kingdom Ltd, 202b, Worle Parkway, Weston-super-Mare, BS22 6WA, United Kingdom (CE body no.0120) in accordance with Module B of the PPE Regulation. The EC quality assurance system for this device has been carried out by SGS Fimko Oy, Takomotie 8, FI-00380 Helsinki, Finland. (CE body no. 0598) and SGS United Kingdom Ltd, 202b, Worle Parkway, Weston-super-Mare, BS22 6WA, United Kingdom (CE body no.0120) in accordance with Module D PPE Regulation (EU) 2016/425 and as brought into UK law and amended.

Testing

Testing and technical file review are integral parts of our design and manufacturing process. External verification of products is undertaken where appropriate, using government approved Notified Bodies.

All products have been thoroughly type tested. Each product is supplied with a certificate of conformance and individual record of thorough examination or test.

Language

It is essential for the safety of the user that if this product is re-sold outside of the original country of destination, the reseller shall provide instructions for use, maintenance, inspection and repair in the language of the country where it will be used.

Product IPR

Intellectual property rights apply to all REID Lifting Ltd products. There are patents in place, or pending, for:

PORTAGANTRY® | **PORTAGANTRY**^{RAPIDE} | **PORTA**DAVIT^{QUANTUM} | **T**DAVIT[™]

All product names are trademarks of REID Lifting Ltd:

PORTAGANTRY® | **PORTAGANTRY**^{RAPIDE} | **PORTA**DAVIT[™] | **PORTA**BASE[™] | **T**DAVIT[™] | **PORTA**QUAD[™]

Product Labelling Key

Safety Labels



Insert and secure the bolt before loading the system.



Insert the detent pin and fully engage before loading the system.



Insert the clevis pin and secure with the clip before loading the system.



Restraint point only.



Read the operational manuals before using the system.



Ensure the pin is fully engaged.

Serial Labels

1. Product Number
2. Serial Number
3. WLL
4. Year of Manufacture
5. Standards
6. ATEX
7. Max Moment



The system is not suitable for fall arrest applications.



The system is suitable for fall arrest applications. Specify number of users. Max weight of 150kg.

➤ Product Labelling



Product labelling

The following labels must be present on your system and must be legible.

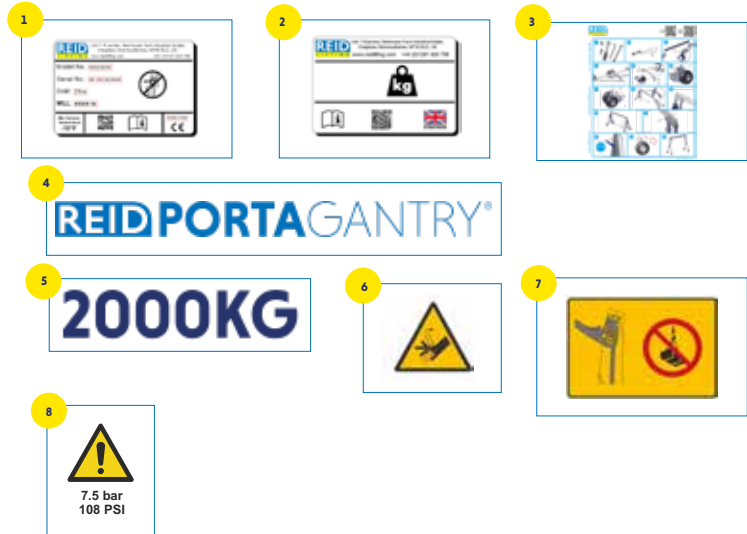

➤ Product Identification & Inspection Record



Marking

The serial labels indicate:

- The product identification number
- The product's unique serial number
- The goods' capacity (WLL) of the device
- The year of manufacture
- The standards to which the device is approved
- The ATEX rating of the product (if applicable)
- CE Marking
- Minimum braking load (MBL)

Insert data from serial numbers found on product into table here:

Contact Us

Head Office, UK

Unit 1 Wyeview
Newhouse Farm Industrial Estate
Chepstow
Monmouthshire
NP16 6UD
United Kingdom

-  +44 (0)1291 620 796
-  enquiries@reidlifting.com
-  www.reidlifting.com

All information herein is copyright protected by REID Lifting Ltd. All company and product names are Trade Mark and Trade Name protected and all REID Lifting Ltd. Product IPR is protected under Patents, Patents Pending and/or Design Rights.



Printed using environment friendly processes and materials.