



## 3M™ DBI-SALA Bracket

› Assembly & Operation Guide

# Contents

Fitting device into Bracket	4
<b>PORTA</b> GANTRY <small>[RAPIDE]</small> 500	6
<b>PORTA</b> GANTRY <small>[RAPIDE]</small> 1000	8
<b>PORTA</b> GANTRY <sup>®</sup> Small & Medium	10
Fitting device into Bracket	12
<b>PORTA</b> GANTRY <sup>®</sup>	14
<b>T</b> DAVIT <sup>®</sup>	16
<b>PORTA</b> DAVIT <small>[QUANTUM]</small> Column	18
<b>PORTA</b> DAVIT <small>[QUANTUM]</small> Backstay	20
<b>PORTA</b> DAVIT <sup>®</sup> 500	22
<b>PORTX</b> <sup>®</sup> DAVIT Single Winched	24
<b>PORTX</b> <sup>®</sup> DAVIT Double Winched	26

# Lightweight. Portable. **Safe.**

Please read the following instructions and guidance notes carefully. These have been designed to aid users in carrying out the correct assembly of the bracket for each of our compatible lifting systems. Systems compatible with this product are:

- **PORTA**GANTRY<sup>[RAPIDE]</sup>
- **PORTA**GANTRY<sup>\*</sup>
- **T**DAVIT<sup>\*</sup>
- **PORTA**DAVIT<sup>[QUANTUM]</sup>
- **PORTA**DAVIT<sup>\*</sup>
- **PORTX**<sup>\*</sup> DAVIT

## General Specification

- Maximum rated capacity for personnel lifting - 150kg
- Ensure the rating of the Winch is always checked before use
- For use with REID lifting products only

## Standards

- EN1496:2017
- EN795:2012 Type B
- EN13157:2004+A1:2009

For further information please refer to the technical data sheet for this product.

# ► Assembly Instructions: Fitting the Device

The following instructions detail the assembly of the 3M™ DBI-SALA device into the universal bracket.



Appropriate PPE should be worn: ► Gloves ► Protective Footwear

Assembling the **3M™ DBI-SALA Winch** onto the bracket for trap plate attachments.

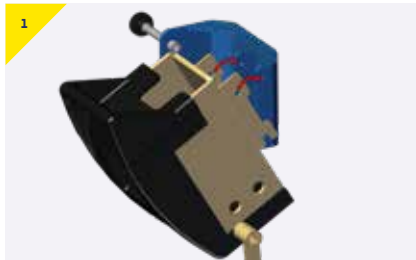

- Remove the pin from the bracket and hook the device as shown.

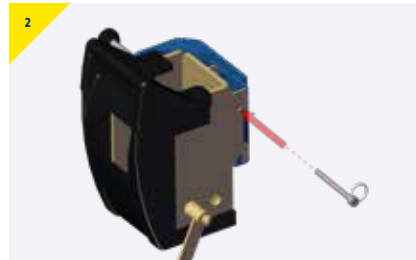

- Secure the device using the pin.



- Secure the pin using the R-Clip provided.



- The device is now ready to use.

**Now install the product onto the trap plate.**

- **NOTE:** The pin supplied with Salalift II Winch is not suitable for use with the bracket as the pin and chain do not work with the orientation of the bracket.

# ➤ Assembly Instructions: PORTAGANTRY <sup>RAPIDE</sup> 500

The following instructions detail the assembly of the 3M™ DBI-SALA bracket [RAWB003520] for the PORTAGANTRY <sup>RAPIDE</sup> 500kg.

Appropriate PPE should be worn: ➤ Gloves ➤ Protective Footwear

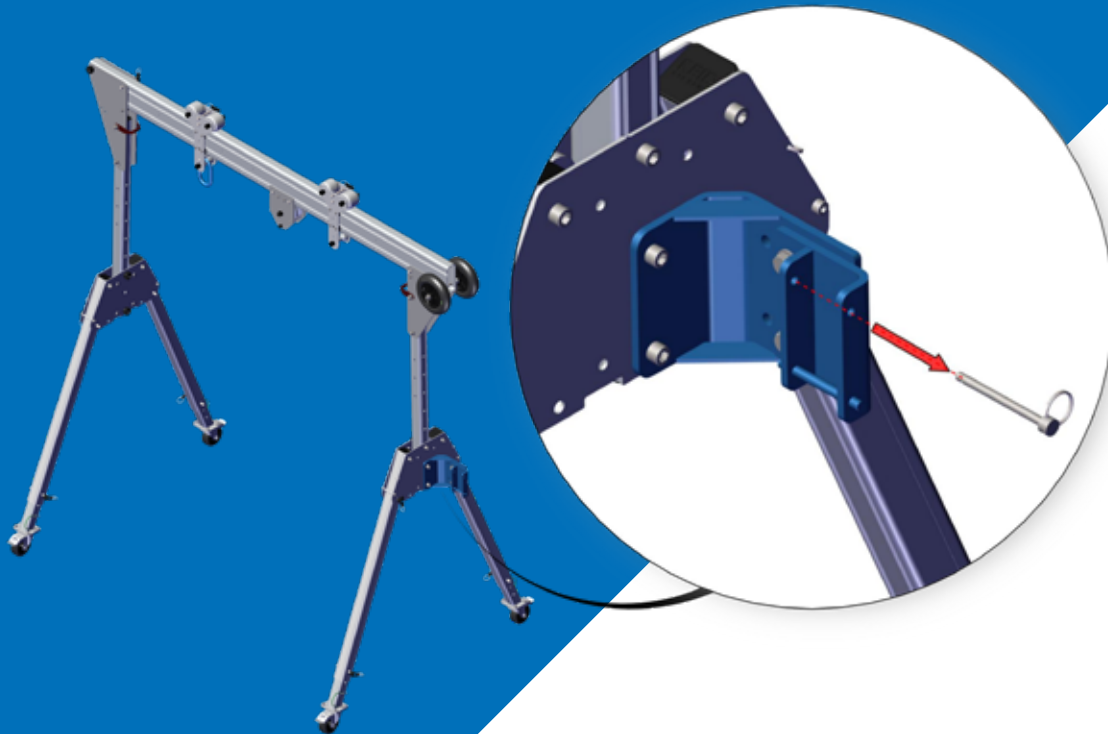

## 3M™ DBI-SALA Bracket - [RAWB003520]

### Assembling the 3M™ DBI-SALA Bracket on PORTAGANTRY<sup>®</sup> RAPIDE<sup>®</sup> 500

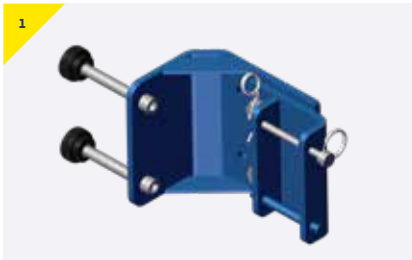

- > The bracket comes with the pins and M12 bolts supplied, as shown above.

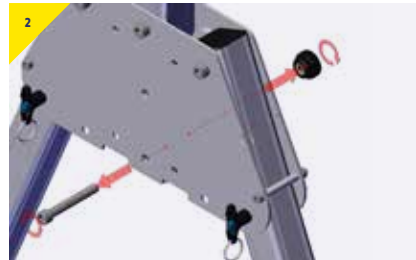

- > Remove the bottom bolt from the trap plate.

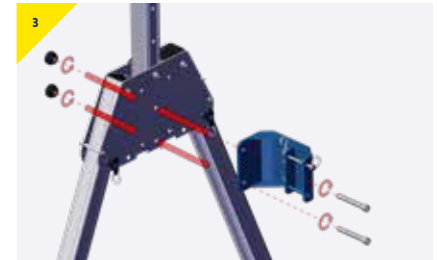

- > Present the bracket to the trap plate using the centre holes, securing with the M12 bolts.

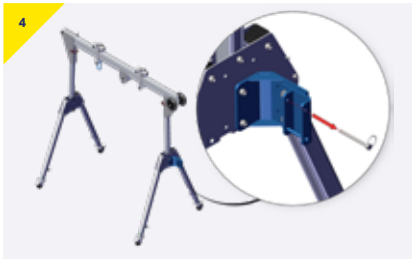

- > The bracket is ready to receive the device.

# ➤ Assembly Instructions: PORTAGANTRY <sup>RAPIDE</sup> 1000

The following instructions detail the assembly of the 3M™ DBI-SALA bracket [RAWB003520] for the PORTAGANTRY <sup>RAPIDE</sup> 1000kg.

Appropriate PPE should be worn: ➤ Gloves ➤ Protective Footwear

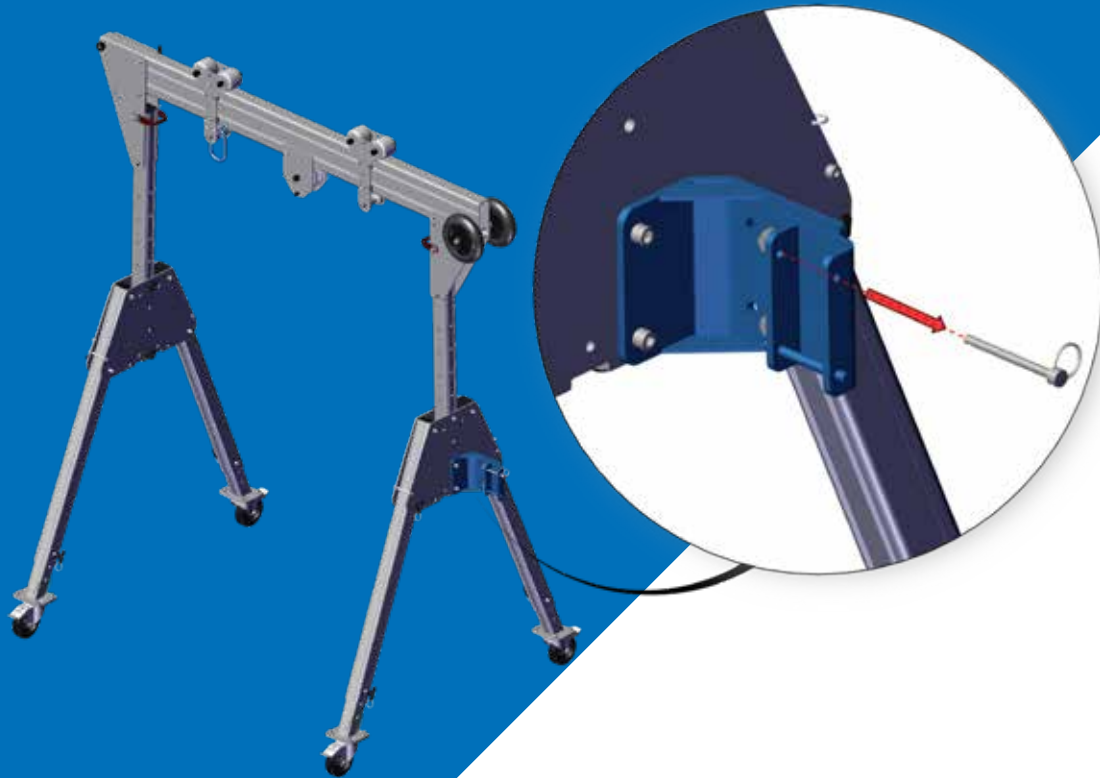



## 3M™ DBI-SALA Bracket - [RAWB003520]

### Assembling the 3M™ DBI-SALA Bracket on PORTAGANTRY<sup>®</sup> RAPIDE<sup>®</sup> 1000

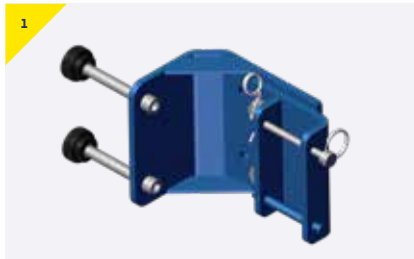

- 1 The bracket comes with the pins and M12 bolts supplied, as shown above.

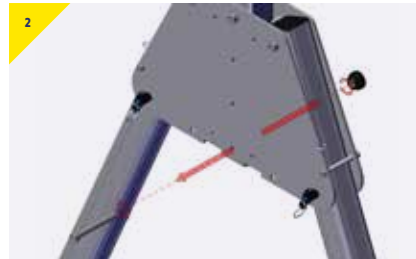

- 2 Remove the bottom bolt from the trap plate.

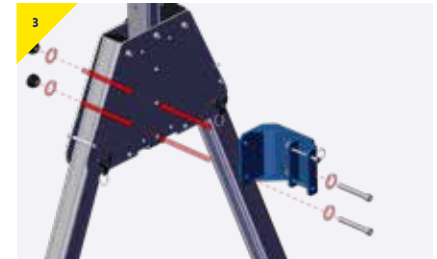

- 3 Present the bracket to the trap plate using the centre holes, securing with the M12 bolts.

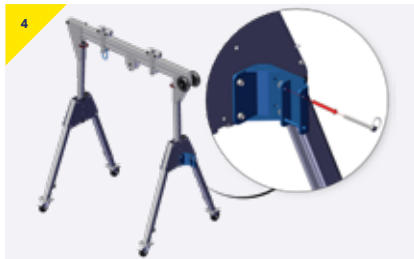

- 4 The bracket is ready to receive the device.

# ➤ Assembly Instructions: PORTAGANTRY® S & M

The following instructions detail the assembly of the 3M™ DBI-SALA bracket [RAWB003522] for the PORTAGANTRY® Small and Medium frame sizes.

Appropriate PPE should be worn: ➤ Gloves ➤ Protective Footwear

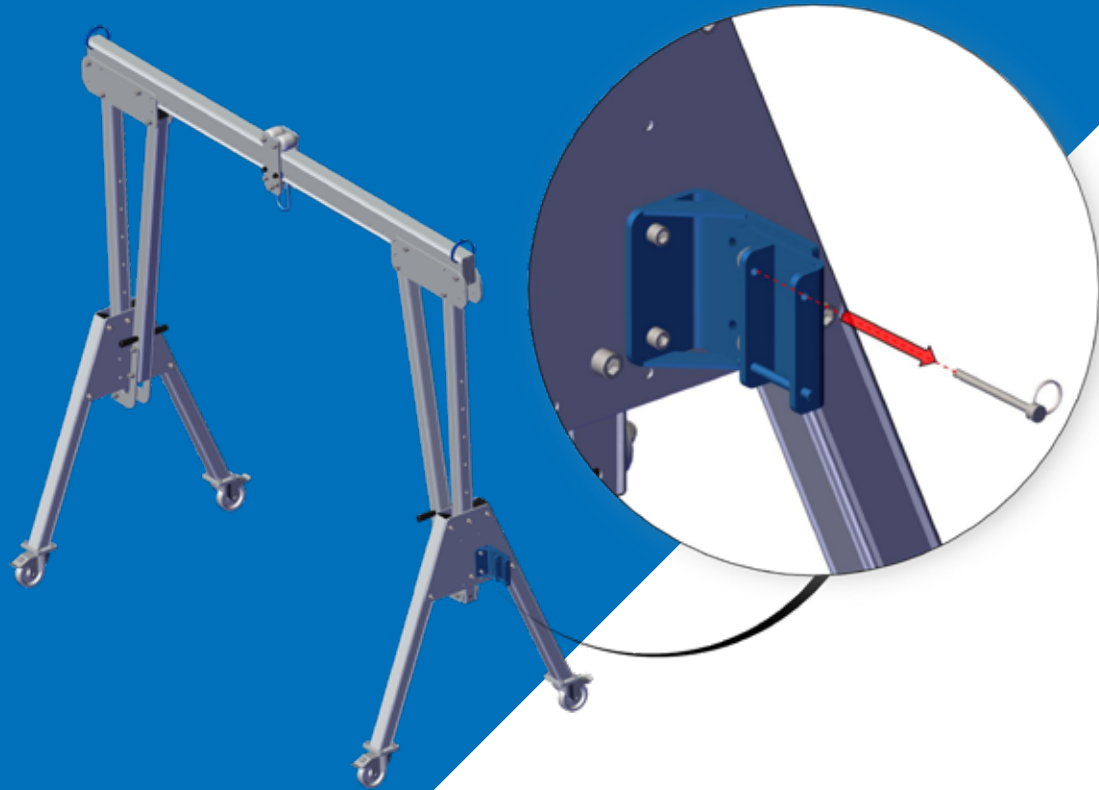

## 3M™ DBI-SALA Bracket - [RAWB003522]

Assembling the **3M™ DBI-SALA Bracket** onto a small or medium **PORTA**GANTRY\*



- > The bracket comes with the pins and M12 bolts supplied, as shown above.

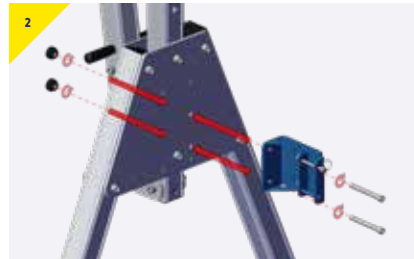

- > Present the bracket to the trap plate using the centre holes, securing with the M12 bolts.

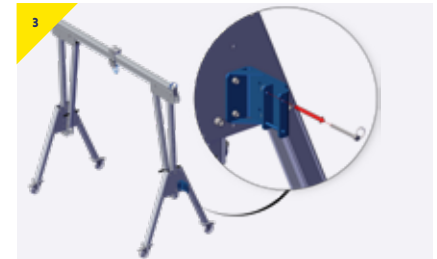

- > The bracket is ready to receive the device.

# ► Assembly Instructions: Fitting the Device

The following instructions detail the assembly of the 3M™ DBI-SALA device into the universal bracket.



Appropriate PPE should be worn: ► Gloves ► Protective Footwear

Assembling the **3M™ DBI-SALA Winch** onto the bracket for column attachments.

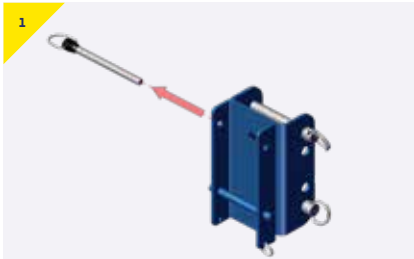

➤ Remove the pin from the bracket.



➤ Present the device to the bracket.

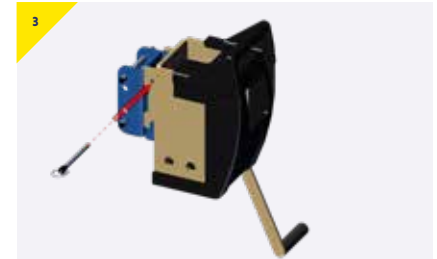

➤ Adjust the position, placing the device attachment arm into the bracket as shown and secure with the pin.



➤ The device is now ready to use.

5  
**Now install the product  
onto the column or backstay.**

# ➤ Assembly Instructions: PORTAGANTRY®

The following instructions detail the assembly of the 3M™ DBI-SALA bracket [RAWB003000] for the PORTAGANTRY®.

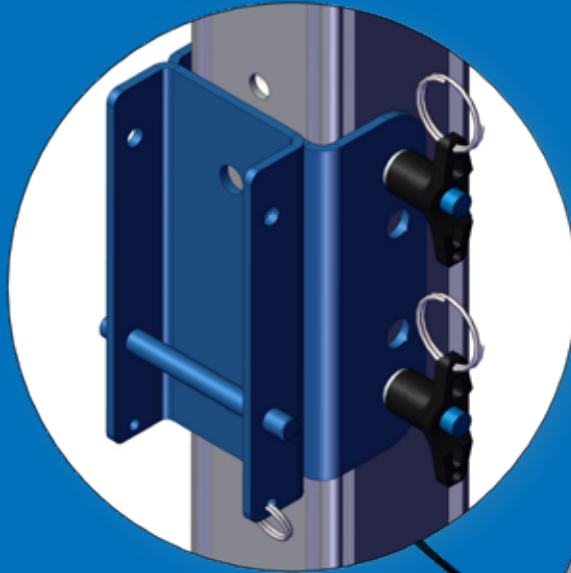

Appropriate PPE should be worn: ➤ Gloves ➤ Protective Footwear

## 3M™ DBI-SALA Bracket - [RAWB003000]

Assembling the **3M™ DBI-SALA Bracket** onto a **PORTAGANTRY™**



➤ The bracket comes with the pins supplied, as shown above.

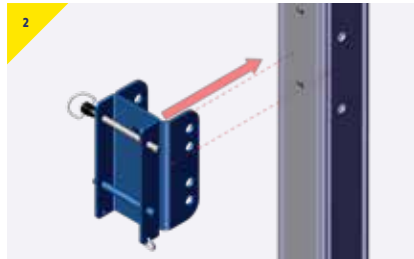

➤ Remove the pins and present the bracket to the winch column, aligned to the holes as shown.

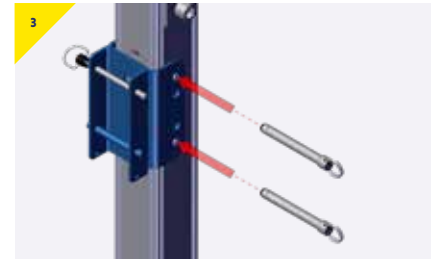

➤ Insert both pins to ensure the bracket is securely attached.



➤ The bracket is secured and ready for the device to be attached.

# ➤ Assembly Instructions: TDAVIT®

The following instructions detail the assembly of the 3M™ DBI-SALA bracket [RAWB003000] for the TDAVIT®.

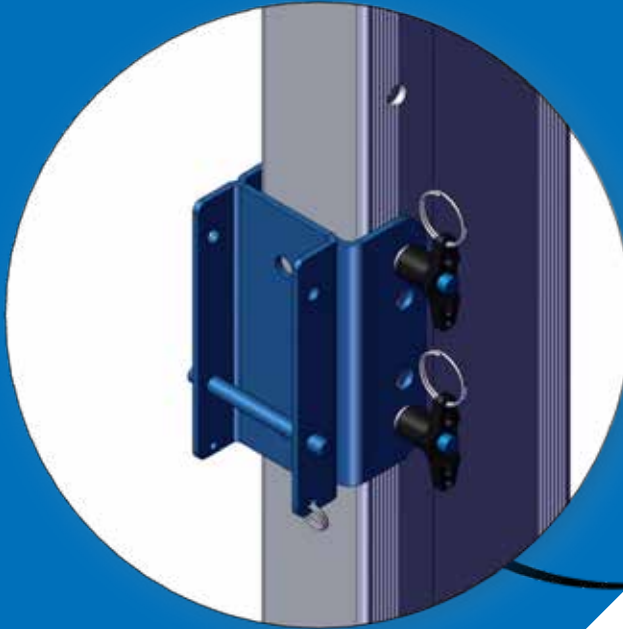

Appropriate PPE should be worn: ➤ **Gloves** ➤ **Protective Footwear**



## 3M™ DBI-SALA Bracket - [RAWB003000]

Assembling the **3M™ DBI-SALA Bracket** onto a **TDAVIT®**



> The bracket comes with the pins supplied, as shown above.

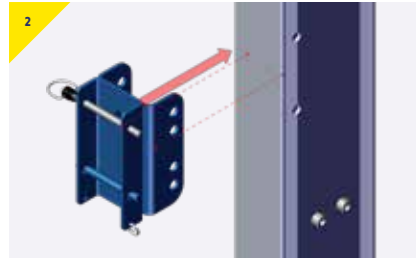

> Remove the pins and present the bracket to the column, aligned to the holes as shown.

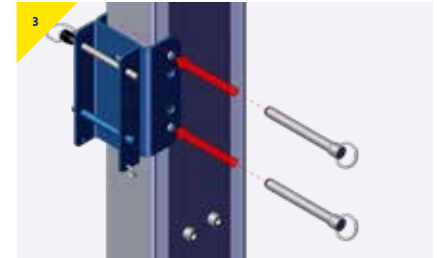

> Insert both pins to ensure the bracket is securely attached.

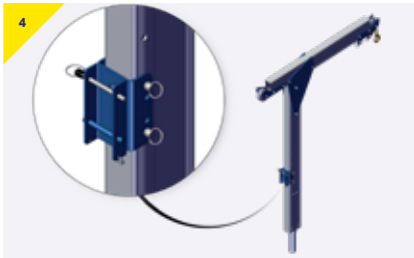

> The bracket is secured and ready for the device to be attached.

# ➤ Assembly Instructions: PORTA DAVIT QUANTUM® Column.

The following instructions detail the assembly of the 3M™ DBI-SALA bracket [RAWB003000] for the PORTA DAVIT QUANTUM® column.

**Warning:** For this configuration a sheave bracket column is required.

Appropriate PPE should be worn: ➤ Gloves ➤ Protective Footwear



## 3M™ DBI-SALA Bracket - [RAWB003000]

Assembling the **3M™ DBI-SALA Bracket** onto a **PORTADAVIT<sup>®</sup> QUANTUM<sup>™</sup>** column.



- > The bracket comes with the pins supplied, as shown above.

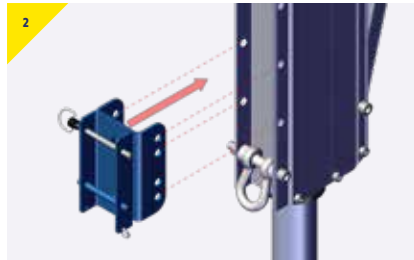

- > Remove the pins and present the bracket to the column, aligned to the holes as shown.

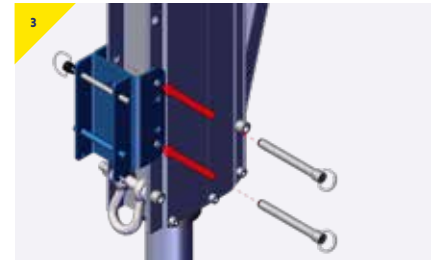

- > Insert both pins to ensure the bracket is securely attached.



- > Present the sheave bracket\* to the top of the column, aligning with the top holes as shown.

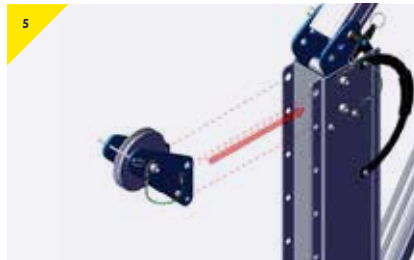

- > Secure using the pins provided.

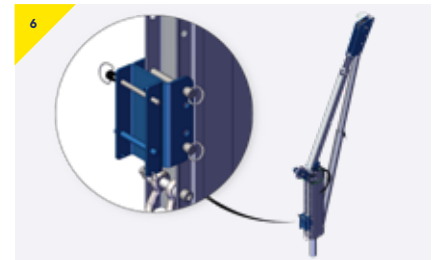

- > The bracket is secured and ready for the device to be attached.

\*RAW000095 - Sheave bracket PDQ Column  
Medium Sheave (4-7mm).

# ➤ Assembly Instructions: PORTADAVIT<sup>®</sup> QUANTUM<sup>®</sup> Backstay.

The following instructions detail the assembly of the 3M™ DBI-SALA bracket [RAWB003003] for the PORTADAVIT<sup>®</sup> QUANTUM<sup>®</sup> Backstay.

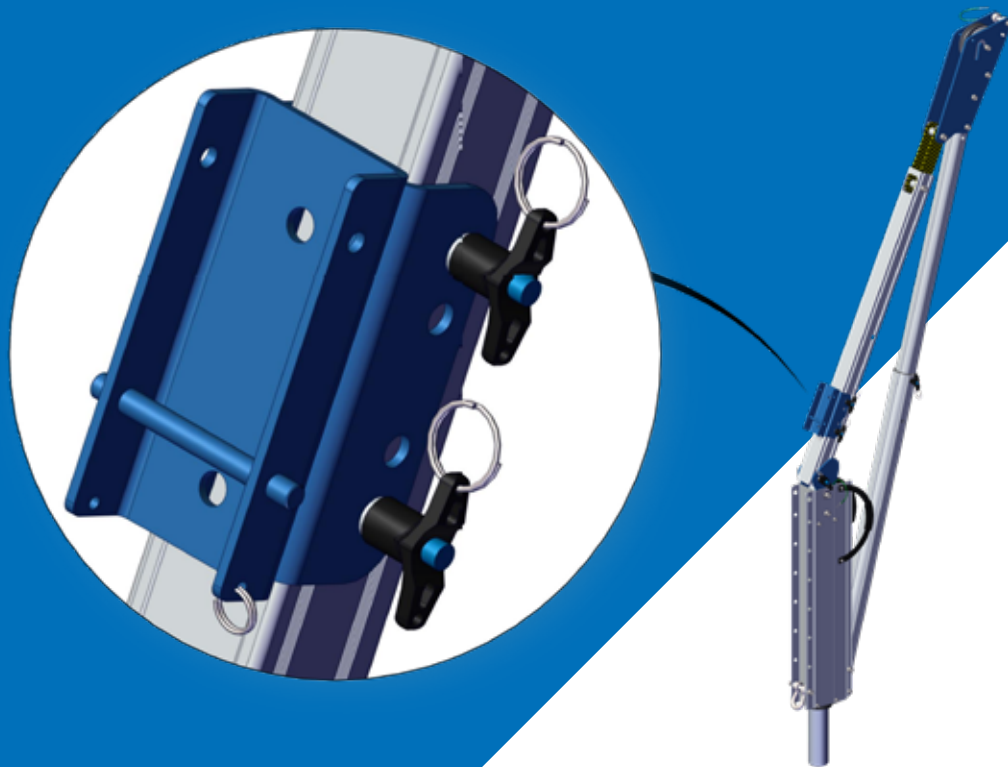

Appropriate PPE should be worn: ➤ Gloves ➤ Protective Footwear

# 3M™ DBI-SALA Bracket - [RAWB003003]

Assembling the **3M™ DBI-SALA Bracket** onto a **PORTADAVIT<sup>®</sup> [QUANTUM]** Backstay.



1 > The bracket comes with the pins supplied, as shown above.

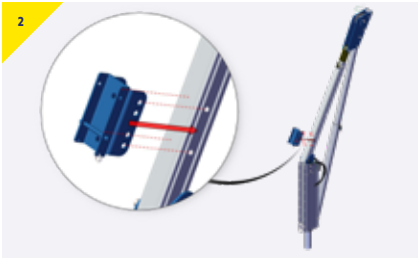

2 > Remove the pins and present the bracket to the backstay, aligned to the holes as shown.



3 > Insert both pins to ensure the bracket is securely attached.

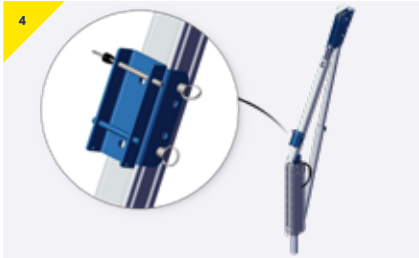

4 > The bracket is secured and ready for the device to be attached.

## ➤ Assembly Instructions: PORTADAVIT 500.

The following instructions detail the assembly of the 3M™ DBI-SALA bracket [RAWB003003] for the PORTADAVIT 500.



Appropriate PPE should be worn: ➤ **Gloves** ➤ **Protective Footwear**

# 3M™ DBI-SALA Bracket - [RAWB003003]

Assembling the **3M™ DBI-SALA Bracket** onto a **PORTADAVIT 500**.



> The bracket comes with the pins supplied, as shown above.

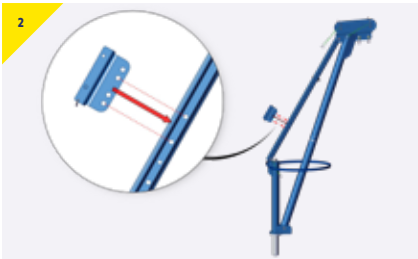

> Remove the pins and present the bracket to the backstay, aligned to the holes as shown.

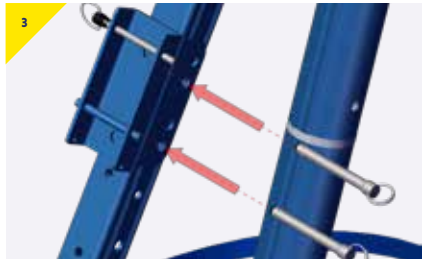

> Insert both pins to ensure the bracket is securely attached.

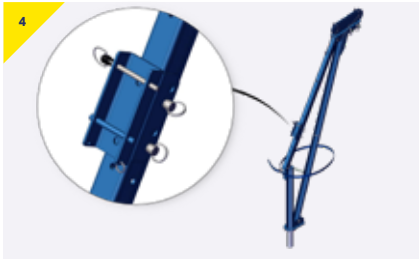

> The bracket is secured and ready for the device to be attached.

# ➤ Assembly Instructions: PORTX® DAVIT Single Winch

The following instructions detail the assembly of the 3M™ DBI-SALA bracket [RAWB003000] for the PORTX® DAVIT with a single winch.

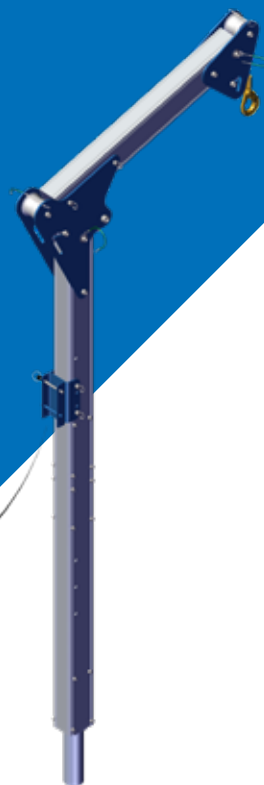
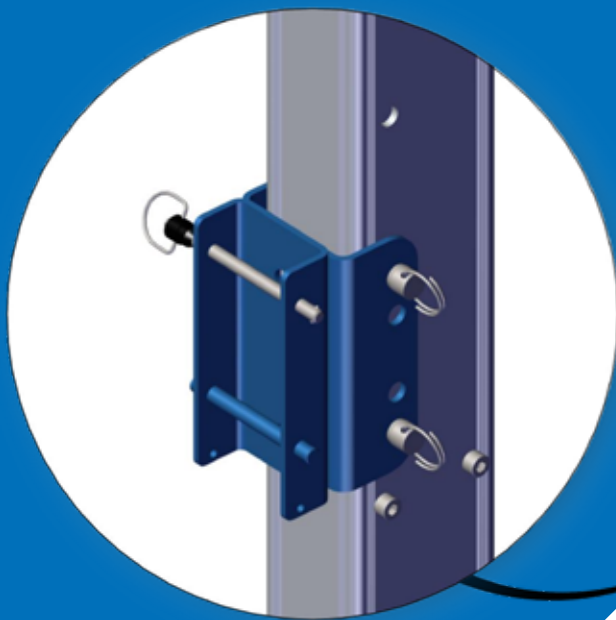

Appropriate PPE should be worn: ➤ Gloves ➤ Protective Footwear



## 3M™ DBI-SALA Bracket - [RAWB003000]

Assembling the **3M™ DBI-SALA Bracket** onto a **PORTX™ DAVIT** with a Single Winch.



> The bracket comes with the pins supplied, as shown above.

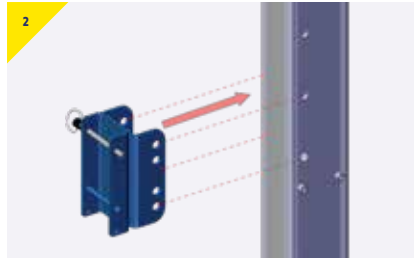

> Remove the pins and present the bracket to the column, aligned to the holes as shown.

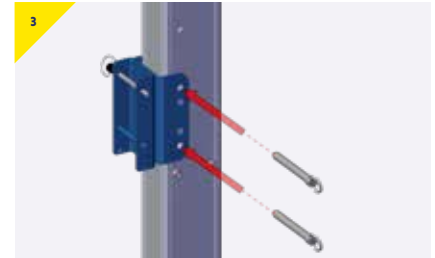

> Insert both pins to ensure the bracket is securely attached.

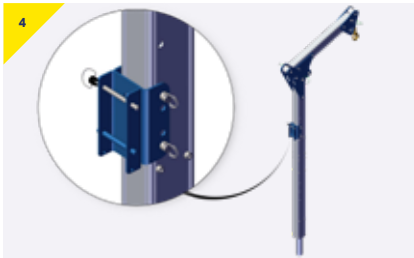

> The bracket is secured and ready for the device to be attached.

# ➤ Assembly Instructions: PORTX<sup>®</sup> DAVIT Double Winch

The following instructions detail the assembly of the 3M™ DBI-SALA bracket [RAWB003009] for the PORTX<sup>®</sup> DAVIT with a double winch.



Appropriate PPE should be worn: ➤ Gloves ➤ Protective Footwear

## 3M™ DBI-SALA Bracket - [RAWB003009]

Assembling the **3M™ DBI-SALA Bracket** onto a **PORTX™ DAVIT** with a double Winch.

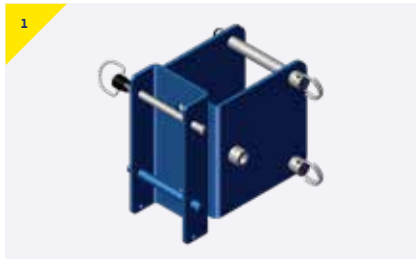

➤ The bracket comes with the pins supplied, as shown above.

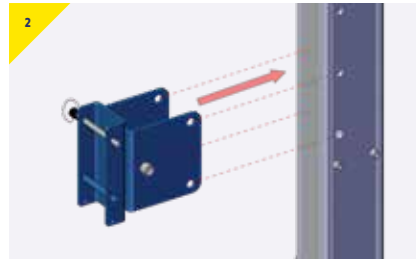

➤ Remove the pins and present the bracket to the column, aligned to the holes as shown.

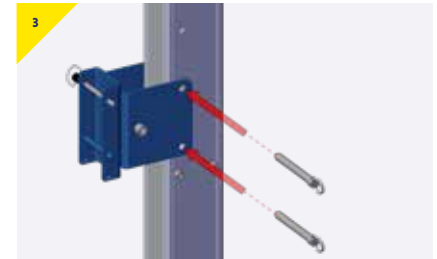

➤ Insert both pins to ensure the bracket is securely attached.

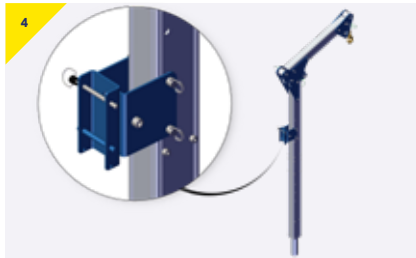

➤ The bracket is secured and ready for the device to be attached.

# Contact Us

## Head Office, UK

Unit 1 Wyeview  
Newhouse Farm Industrial Estate  
Chepstow  
Monmouthshire  
NP16 6UD  
United Kingdom

-  +44 (0)1291 620 796
-  [enquiries@reidlifting.com](mailto:enquiries@reidlifting.com)
-  [www.reidlifting.com](http://www.reidlifting.com)

All information herein is copyright protected by REID Lifting Ltd. All company and product names are Trade Mark and Trade Name protected and all REID Lifting Ltd. Product IPR is protected under Patents, Patents Pending and/or Design Rights.



Printed using environment friendly processes and materials.